

# M192

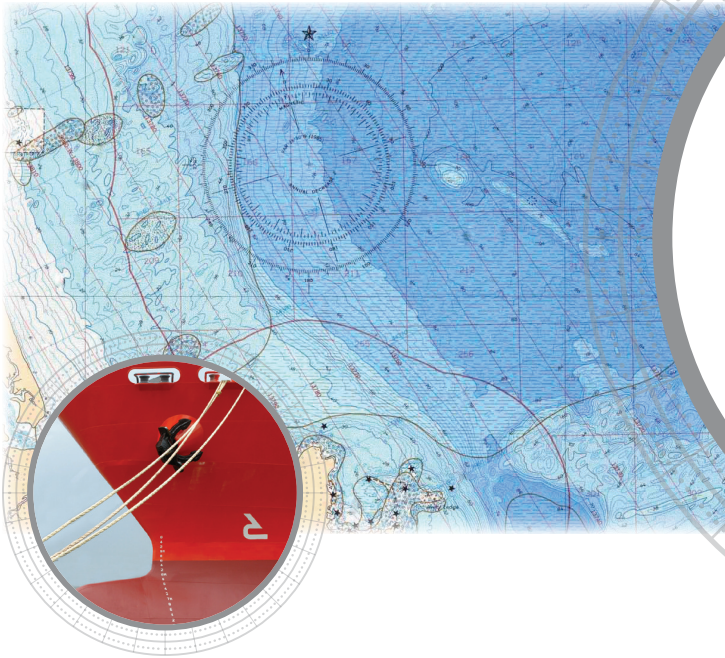

## Narrow-Beam Sensitivity

The M192 features a ceramic-element array with a narrow beamwidth and exceptional sensitivity to provide unmatched bottom detail.

## Options

- Impedance to customer's specifications using matching transformer

## Tank-Mount

# 500 W - 2 kW

## Applications



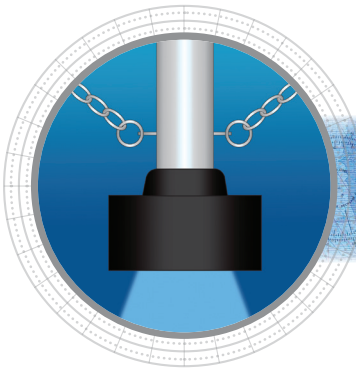

- Deep and shallow-water survey
- Marine navigation

## Features

- Low-ringing array provide excellent target resolution
- Seamless, SEALCAST™, urethane housing resists cuts and abrasion and has excellent, impact resistance
- Available as either a single-frequency or dual-frequency
- Can be adapted for portable mounting



## Technical Information

Frequencies	Configuration	Beamwidth (@-3 dB)	RMS Power (kW)	FOM (dB)	Q	Series Impedance (R-jX)
28 kHz-R	 A	18°	2 kW	-10	6	60-j0(Ω)
28 kHz-N	 B	24°	1.5 kW	-13	8	120-j0(Ω)
33 kHz-D	 C	19°	1 kW	-13	7	90-j0(Ω)
38 kHz-B	 D	20°	1 kW	-11	7	60-j0(Ω)

### Technical Data—28 kHz-R

TVR in dB re 1μPa/Volt at 1 m

RVR in dB re 1 Volt/μPa

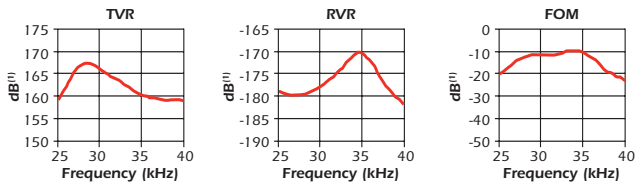

### Directivity Pattern—28 kHz-R

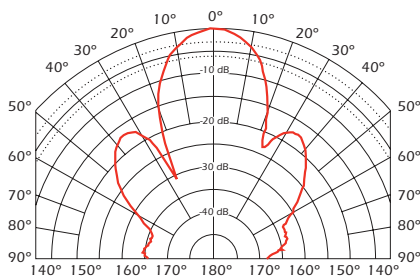

## SPECIFICATIONS

### Weight\*\*:

- A—13 kg (29 lb)
- B—8 kg (17 lb)
- C—9.1 kg (20 lb)
- D—7.3 kg (16 lb)

Acoustic Window: Urethane

### Cable Type\*\*:

C-43  
Shielded twisted pair (2-14 AWG) with braided shield, black neoprene jacket, 10 mm (13/32") diameter

\*Weights may vary depending on the cable length and configuration.  
\*\*Typical cable length is 10 m (33') up to 40 m (130').

## DIMENSIONS

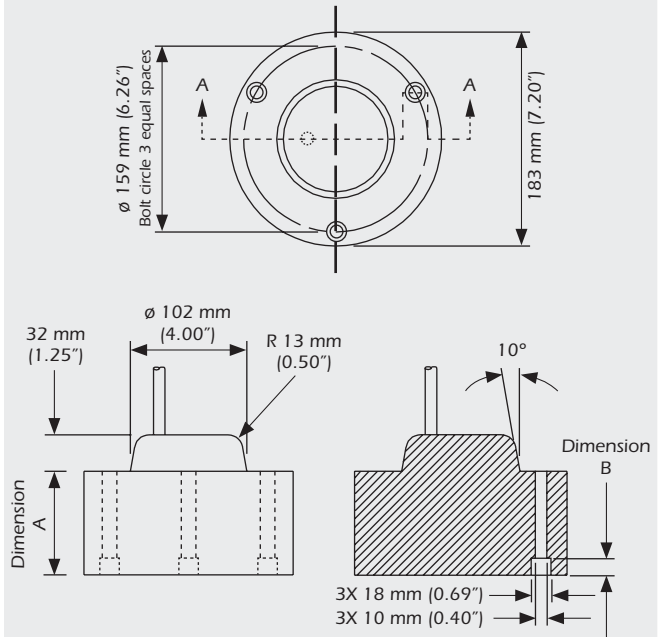

Configuration	Dimension A	Dimension B
A	110 mm (4.32")	34 mm (1.34")
B, C, & D	90 mm (3.56")	15 mm (0.59")