



CTD-N

CTD-NV, CT-NV, CTD-NH, and CT-NH Technical Manual



P/N 95F-6000-00 (February 2017)

© 2017 Teledyne RD Instruments, Inc. All rights reserved.



Information included herein is controlled by the Export Administration Regulations (EAR) and may require an export license, license exception or other approval from the appropriate U.S. Government agency before being exported from the United States or provided to any foreign person. Diversion contrary to U.S. law is prohibited.

Table of Contents

Introduction.....	1
Maximum Operating Depth.....	1
System Configuration Requirements.....	2
Pull-Down Menus	2
Customer Service.....	3
Main External Components	4
CTD-N Options.....	7
Specifications.....	8
Outline Installation Drawings	10
Unpacking the CTD-N and Connecting It to Your Computer	12
Unpacking the CTD-N	12
Battery Pack	12
Standard Items	12
Optional Items.....	13
Installing CTDPro and Selecting the CTD-N.....	13
Installing CTDPro	13
Selecting the CTD-N	14
Communication Interfaces	14
RS-232 Interface	14
RS-485 Interface Option.....	15
CMOS Interface Option	15
Connecting the CTD-N to Your Computer	15
Connecting to the RS-232 Interface	15
Using the CTD-N End Cap Switch.....	16
Connecting a PC to the CTD-N with an End cap Switch	16
Connecting to the RS-485 Interface	17
Changing the Serial Port	18
Changing the Baud Rate	19
Changing the Baud Rate of the Serial Port	19
Automatically Changing the Baud Rate of the Serial Port to the Baud Rate of the CTD-N.....	20
Changing the Baud Rate of the CTD-N and the Serial Port.....	20
Connecting and Setting up Communications with a GPS	21
Checking, Configuring, & Deploying the CTD-N	23
CTD-N Configuration Settings	23
Running Modes	24
Averaged Data.....	25
Sampling Rate	25
Time and Date	26
Serial Number	26
Communications Options	27
Predeployment Checks.....	28
Verifying Battery Pack Capacity and Memory Requirements	28
Running the Diagnostic Tests	32
Configuring and Deploying the CTD-N.....	36
Configuring and Deploying the CTD-N in Continuous Mode	36
Configuring and Deploying the CTD-N in Interval Mode	38
Configuring and Deploying the CTD-N in Delayed Start Continuous Mode.....	41
Configuring and Deploying the CTD-N in Delayed Start Interval Mode.....	44
Using Battery End Cap Enabled Interval Mode	47
Battery End Cap Enabled – Delayed Start Interval	47
CTD-N Autolog Feature.....	48
Selecting and Activating the Autolog Feature	49
Autolog Typical Applications and Procedures	50
Retrieving and Displaying Data from the CTD-N.....	53

Downloading and Saving Data from the CTD-N.....	53
Exporting and Viewing Saved Data.....	55
Exporting Saved Data.....	56
Viewing Data That Have Been Exported to a Text File.....	57
Displaying, Printing, and Saving Graphs.....	58
Displaying Data versus Pressure or Time.....	59
Viewing Data on a Graph.....	59
Zooming in and Out of a Graph.....	60
Setting up a Graph.....	60
Saving a Graph.....	62
Previewing and Printing a Graph.....	63
Viewing File Information.....	63
Erasing All the Data Files.....	64
Acquiring, Displaying, and Saving Data in Real Time.....	66
Starting Data Acquisition.....	66
Stopping Data Acquisition.....	69
Viewing Saved Data.....	69
CTD-N Acquisition Window Displays.....	70
CTD-N Maintenance.....	71
Recommended Maintenance.....	71
Cleaning and Inspecting the CTD-N.....	72
Replacing the Battery Pack.....	74
Oil Fill Procedure and Capillary Tube Installation.....	78
Installing a CTD-N End Cap Switch Kit.....	81
Firmware Updates.....	82
APPENDIX A: Measured and Calculated Parameters.....	85
Parameters Measured by the CTD-N.....	85
Parameters Calculated by the CTD-N.....	85
Parameters Calculated by CTDPro.....	86
APPENDIX B: Bulkhead Connector Wiring.....	87
APPENDIX C: Optional Sensors.....	91
Seapoint Turbidity Sensor.....	95
Selecting the Range for the Seapoint Turbidity Sensor.....	95
Calibrating the Seapoint Turbidity Sensor.....	97
Seapoint Fluorometer Sensor.....	98
Selecting the Range for the Seapoint Fluorometer Sensor.....	98
Calibrating the Seapoint Fluorometer Sensor.....	99
Calibrating the External Sensors.....	100
APPENDIX D: CTD-N Commands.....	103
CTD-N Operating Modes.....	103
Command Properties.....	103
Entering Commands.....	104
START.....	108
***R.....	109
***O.....	110
***C.....	111
***I.....	112
***D.....	113
***E.....	114
CDATE.....	115
SRATE.....	116
DTIME.....	117
DDATE.....	118
ITIME.....	119
OTIME.....	120

RCAL.....	121
CCKO, RCKO, SCKO.....	122
CSOT, RSOT, SSOT.....	123
CCOP, RCOP, SCOP.....	124
SB.....	125
MODE.....	126
CAOP, RAOP, SAOP, #N.....	127
TIME.....	129
DATE.....	130
DIAG.....	131
ZMEM.....	132
FDMP.....	133
AVGI.....	134
CHKF.....	135
DDMP.....	136
BDMP.....	137
DLEN.....	138
LOG.....	139
S/N.....	140
ROP.....	141
VER.....	142
WHO.....	143
ADR.....	144
RDM.....	145
DIR.....	145
C.....	147
CH.....	147
?.....	149
S.....	150
SC.....	151
SFRM.....	152
GAIN0.....	154
GAIN1.....	155

APPENDIX E: Warranty, Liability, and RMA Return Procedure	156
Teledyne RD Instruments Limited Warranty	156
Liability	156
Returning CTDs to TRDI for Service	157
Domestic Shipments.....	157
European Shipments	158

List of Figures

Figure 1.	The Location of the CTD-NV Main External Components	4
Figure 2.	The Location of the CTD-NH Main External Components.....	5
Figure 3.	The Location of the CT-NH Main External Components.....	6
Figure 4.	Outline Installation Drawing, CTD-NV & CT-NV, NXIC Vertical	10
Figure 5.	Outline Installation Drawing, CTD-NH & CT-NH, NXIC Horizontal	11
Figure 6.	The Properties Dialog Box.....	14
Figure 7.	CTD-N Setup—with RS-232 Interface	16
Figure 8.	CTD-N Setup with B176-207 Battery Adapter Cable	17
Figure 9.	CTD-N Setup—with RS-485 Interface	18
Figure 10.	The Communication Properties Dialog Box	19
Figure 11.	The Communication Rate Dialog Box	21
Figure 12.	The Navigation Setup Dialog Box	21
Figure 13.	The CTD-N Configuration Dialog Box.....	24

Figure 14.	Run Time Diagram, Including Average Times, for One Interval Time Cycle	26
Figure 15.	The Advanced Settings Dialog Box	27
Figure 16.	The Battery Life Dialog Box—Entering the Battery Pack Capacity Sample Rate and Average Times	29
Figure 17.	The Battery Life Dialog Box—Selecting the Running Mode	30
Figure 18.	The Battery Life Dialog Box—Deployment Summary	31
Figure 19.	The Save As Dialog Box for Battery Pack Information Files	32
Figure 20.	The Diagnostics Dialog Box	33
Figure 21.	Save As Dialog Box for Diagnostics Data Files	34
Figure 22.	Results of Diagnostic Testing in the Diagnostics Dialog Box	34
Figure 23.	Flowchart for the CTD-N Autolog Feature	49
Figure 24.	Activating the Autolog feature in the Advanced Settings dialog box	50
Figure 25.	The Download Dialog Box	54
Figure 26.	The Save As Dialog Box for CTD Data Files	54
Figure 27.	The Export Dialog Box	56
Figure 28.	The Open Dialog Box for CTD Data Files	57
Figure 29.	Example CTD-N Data File Printout	58
Figure 30.	The Graphics Display Opened to the Conductivity Graph	60
Figure 31.	The 2D Chart Control Properties Dialog Box	61
Figure 32.	The Temperature Graph	61
Figure 33.	The Pressure Graph	62
Figure 34.	Save Graph Dialog Box	62
Figure 35.	The Save As Dialog Box for Image Files	63
Figure 36.	The File Information Window	64
Figure 37.	The Channel Configuration Dialog Box	67
Figure 38.	The CTD-N Acquisition Window	68
Figure 39.	The Acquisition Setup Dialog Box	68
Figure 40.	The Save As Dialog Box for ASCII Data Files	69
Figure 41.	The CTD-N Acquisition Window with Real-Time Displays of Data	70
Figure 42.	Cleaning the CTD-NH Sensor Head	73
Figure 43.	Contents of NXIC CTD End-cap Switch Kit	81
Figure 44.	CTD-N Firmware Updates	84
Figure 45.	4-pin Bulkhead Connector Face View	87
Figure 46.	6-Pin Bulkhead Connector Face View	88
Figure 47.	Test Cable Wiring	89
Figure 48.	Battery Adapter Cable Wiring P/N B176-207	90
Figure 49.	Option 1 & Option 2 Connectors with 6-pin Connector on Lower End Cap	92
Figure 50.	Option 1 and Option 2 Connectors Face View	93
Figure 51.	CTD-N with Seapoint Turbidity Sensor Connected to the Option 1 Connector	96
Figure 52.	The Sensor Setup Dialog Box—Selecting Seapoint Turbidity Sensor Range	97
Figure 53.	The Sensor Setup Dialog Box—Selecting Seapoint Fluorometer Sensor Range	99
Figure 54.	The Calibrate Sensor Dialog Box—Selecting the Sensor	100
Figure 55.	The Calibrate Sensor Dialog Box—Setting the Low	101
Figure 56.	The Calibrate Sensor Dialog Box—Setting Additional Standard Points Including the High Point Standard	102
Figure 57.	The Calibration Results Window	102
Figure 58.	The Terminal Window	104

List of Tables

Table 1:	Optional Items Available from TRDI	13
Table 2:	Recommended Maintenance	71
Table 2:	NXIC End cap Switch Kit Contents	81

Table 3:	Bulkhead Connector Components.....	87
Table 4:	Pigtail Color Codes/Functions	87
Table 5:	CTD-N Bulkhead 4-pin Connector to Computer Connections	88
Table 6:	CTD-N Bulkhead 4-pin Connector to Power Supply Connections.....	88
Table 7:	CTD-N 6-pin Bulkhead Connector to Computer Connections	88
Table 8:	CTD-N 6-pin Bulkhead Connector to Power Connections	88
Table 9:	Test Cable Pin Out.....	89
Table 10:	Option Connectors Components.....	92
Table 11:	Option 1 Connector Connections	93
Table 12:	Option 2 Connector Connections	93
Table 13:	Seapoint Turbidity Sensor Range Selections.....	95
Table 14:	Fluorometer Sensor Range Selections.....	98
Table 15:	CTD-N Commands.....	105

Revision History

February 2017

- Updated overview graphics with the Capillary Tube Assembly.
- Added a recommended maintenance list to the maintenance chapter.
- Updated cleaning procedure.
- Updated Oil Fill Procedure and Capillary Tube Assembly.
- Updated TRDI website address to <http://www.teledynemarine.com/rdi>

April 2016

- Updated Internal Memory specification from “128MB; 256MB optional” to 256MB. All NXIC CTDs use a 256MB internal recorder.
- Updated the CAOP, RAOP, SAOP commands.
- Added the #N command.
- Updated the SFRM and ADR commands.
- Combined CCKO, RCKO, SCKO commands into one page to better explain how the commands interact.
- Combined CSOT, RSOT, SSOT commands into one page to better explain how the commands interact.
- Combined CCOP, RCOP, SCOP commands into one page to better explain how the commands interact.

August 2014

- Updated caution and added graphic to page 2 and 73 - As with all high pressure instrumentation, observe caution while using the CTD-N or after exposing it to high pressures. Wear safety glasses and keep head and body clear of the end-cap while opening.
- Added the CH command.
- Added Valeport output to SFRM command (ICN152).
- Updated conductivity specifications.
- Added storage temperature to specifications.
- Updated patent numbers.

- Corrected how to request a Return Material Authorization (RMA).
- Removed the CTD-N C-Cell Battery Holder section; this option is not available.
- The instrument is capable of storing 17 separate files, not 22 as shown on page 49
- Removed “In addition, you can verify calibration of the CTD-N conductivity sensor with a conductivity loop test device” from page 32; no loop test device is available.

January 2013

- Updated conductivity specifications.

December 2012

- Updated conductivity specifications.

March 2012

- Updated Cleaning and Inspecting the CTD section.
- Changed “The water salinity in PSU-78 units” to “The seawater salinity in accordance to PSS78 (Practical Salinity Scale 1978)”.
- Corrected part number for oil fill kit syringe.
- Added note that Windows 7 only COM port 1 is supported.
- Added note that Windows 7 will not save any data files to the folder selected in the dialog box. Instead it saves to the desktop by default.

November 2011

- Updated outline installation drawing 96F-6002 to rev A.
- Updated conductivity specifications for accuracy and drift.
- Corrected part number for oil fill capillary body assembly.

November 2010

- Combined CTD-NV, CT-NV, CTD-NH, and CT-NH models into one manual.
- Updated System Configuration Requirements.
- Added patent numbers.
- Added CTD-N Options section.
- Updated specifications.
- Added outline installation drawings.
- Updated Installing CTDPro section.
- Added instructions for End Cap Switch.
- Incorporated FSI Application Notes into the CTD-N manual including Oil Fill procedure, Autolog feature, C-cell battery holder model, and firmware updates.
- Updated Cleaning and Inspecting the CTD-N section.
- Added test cable and battery adapter cable drawings.

April 2010

- Converted FSI NXIC manual to TRDI format and CTD model numbers.
- Added 6-pin connector pin-out.



CTD-N Technical Manual

Introduction

The Teledyne RD Instruments CTD-N (includes CTD-NV, CT-NV, CTD-NH, and CT-NH models) is a ruggedized, extremely durable sensor that is designed to collect high precision, scientific quality salinity data by measuring conductivity, temperature, and pressure. The instrument measures conductivity using a patented inductively coupled highly stable NXIC (Non-eXternal Inductive Conductivity) sensor that is designed for long term, low maintenance deployments, even in coastal regions where biological fouling is a problem. Temperature is measured with an aged, high accuracy thermistor mounted directly in the water flow path of the conductivity sensor. On CTD models, pressure is measured using a fully temperature compensated precision micro-machined silicon transducer.

The CTD-N optionally includes four additional DC input channels and an RS-232 channel. Included with this option are additional connectors for connecting external sensors. The DC input channels interface with 0–5 VDC output sensors, including dissolved oxygen, pH, chlorophyll, light transmission, and others. The RS-232 channel interfaces with many external sensors via an RS-232 serial connection. Two of the DC channels include two logic outputs for controlling sensor gains or other sensor functions. The CTD-N also provides power for the sensors.

Measured conductivity, temperature and pressure data, along with calculated salinity and sound velocity and external sensor data, are continuously recorded to internal memory at selectable sample rates from 1 to 15 Hz. For each sample, the time and date are also recorded. All data are saved to a file which can be downloaded to a computer after retrieval of the instrument. Multiple files for multiple deployments can be recorded to memory and downloaded separately.

The CTD-N is configured using CTDDPro, a Microsoft Windows® based software program included with the instrument. With CTDDPro you can configure and deploy the instrument, download and save the data from the instrument, view and print graphs of the data, and export the data to a text or spreadsheet file. In addition, the data can be exported to CTDDPost, a post processing software program available from TRDI that provides a means of processing, displaying, graphing, printing, and saving processed CTD data.

Maximum Operating Depth

IMPORTANT! The CTD-N is rated for a maximum operating depth that is based on the pressure transducer selected. Consult the manufactured configuration sheet supplied with the instrument for

its maximum operating depth. **Do not** exceed 125% of full scale when using or calibrating the instrument as permanent damage **will occur**.



Caution label on housing

	<p>CAUTION. As with all high-pressure instrumentation, observe caution while using the CTD-N or after exposing it to high pressures. Wear safety glasses and keep head and body clear of the end-cap while opening.</p>
---	--

System Configuration Requirements

TRDI software requires a Windows® compatible computer with the following specifications:

- Windows XP® or Windows 7®
- Pentium III 600 MHz class PC (higher recommended)
- 1GB of RAM (2GB or more RAM recommended)
- 50 MB Free Disk Space plus space for data files (A large, fast hard disk is recommended)
- One Serial Port (two or more High Speed UART Serial Port recommended)
- Minimum display resolution of 1024 x 768, 256 color (higher recommended)
- CD-ROM Drive
- Mouse or other pointing device

Pull-Down Menus

Like most programs, CTDPro uses pull-down menus, which are opened from the menu bar in the program's Main window by pointing to the item with the mouse pointer and clicking the left mouse button. When the menu is open, you can select an item from it in the same manner.

In many of the procedures presented in this manual, the ► symbol is used to represent a sequence of menu item selections. For example, "Choose File ► Open" means select File from the menu bar, and then choose Open from File menu when it opens.

Customer Service

TRDI welcomes your feedback. Please contact TRDI customer service to offer any comments or suggestions or to request technical support. TRDI can be contacted using any of the following means:

Teledyne RD Instruments

14020 Stowe Drive
Poway, California 92064

Phone +1 (858) 842-2600

FAX +1 (858) 842-2822

Sales – rdisales@teledyne.com

Field Service – rdifs@teledyne.com

Teledyne RD Instruments Europe

2A Les Nertieres
5 Avenue Hector Pintus
06610 La Gaude, France

Phone +33(0) 492-110-930

FAX +33(0) 492-110-931

Sales – rdie@teledyne.com

Field Service – rdiefs@teledyne.com

Client Services Administration – rdicsadmin@teledyne.com

Web: <http://www.teledynemarine.com/rdi>

For all your customer service needs including our emergency 24/7 technical support, call
+1 (858) 842-2700

Self-Service Customer Portal

Use our online customer portal at <http://www.teledynemarine.com/rdi> and click on the **Support** link to download manuals, firmware updates, software, or other Teledyne RDI documentation. Log into your account and then click the **Software/Firmware** link or **Documentation** link.

The information, descriptions and illustrations in this manual are the property of Teledyne RD Instruments (TRDI), and may be disclosed only to those persons or organizations specifically authorized by TRDI. Duplication of any part of this manual is strictly prohibited unless authorized in writing by TRDI.

The technologies used in the CTD-N sensor are currently under patent protection (5,959,455), both in the United States of America and internationally. TRDI will aggressively utilize its full rights under patent law to protect its interest in these technologies.



logo is a registered trademark of Teledyne RD Instruments.

Delrin® is a registered trademark of E. I. du Pont de Nemours and Company.

©Copyright 2010 by Teledyne RD Instruments.

Main External Components

The main external components of the CTD-NV are shown in Figure 1. The conductivity, temperature, and pressure sensors are located on the top end cap. The conductivity sensor is free flushing with no exposed electrodes that can foul or external fields that can affect calibration. The temperature sensor is aged and therefore highly stable and is directly in the water flow path of the conductivity sensor. The pressure sensor is exposed to ambient pressure through a pressure port and an oil-filled capillary. The oil provides the required pressure coupling and is an electrical insulator that prevents corrosion due to the dissimilar metal compositions of the transducer and instrument housing. Capillary action ensures the oil remains contained in the pressure port. A single 4-pin (Direct Reading units) or 6-pin (Battery or External Sensor Interface units) bulkhead connector on the lower end cap provides RS-232, RS-485 or CMOS TTL level digital communications and inputs external power.

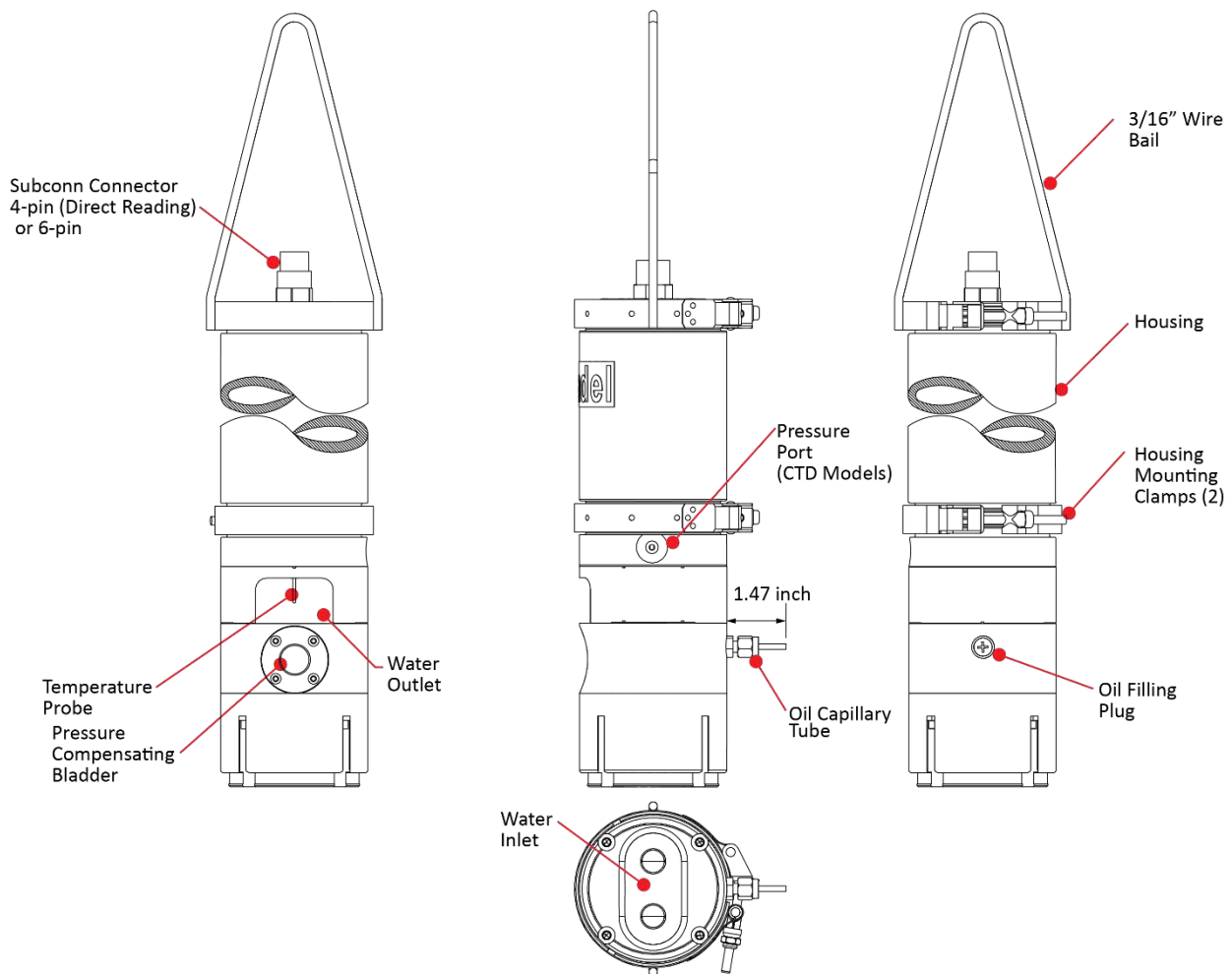

Figure 1. The Location of the CTD-NV Main External Components



NOTE. Shown with optional wire bail and with the oil capillary tube installed. The tube extends 1.47 inch from the housing. Make sure that the tube is not blocked when mounting the CTD.

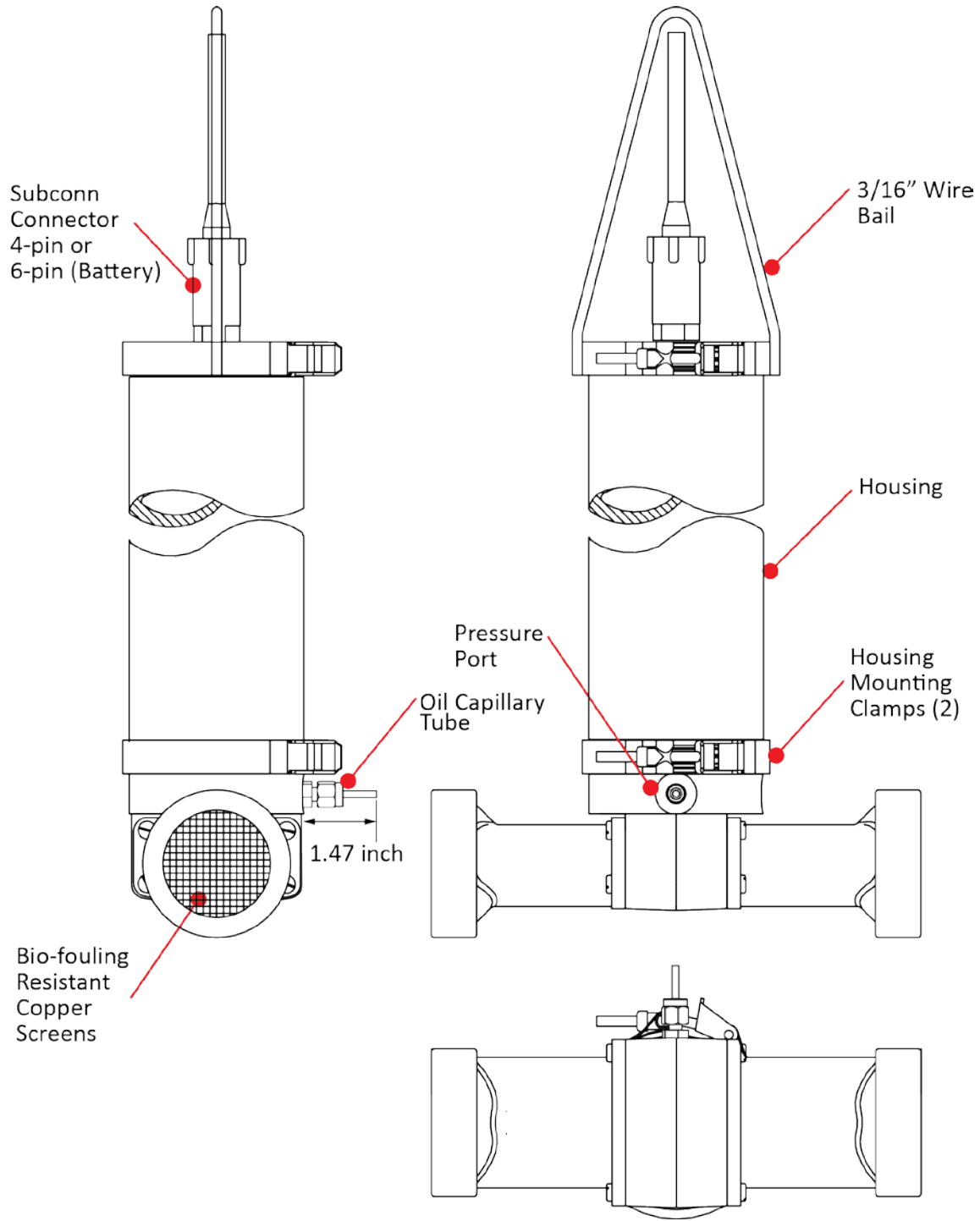

Figure 2. The Location of the CTD-NH Main External Components



NOTE. Shown with optional wire bail and with the oil capillary tube installed. The tube extends 1.47 inch from the housing. Make sure that the tube is not blocked when mounting the CTD.

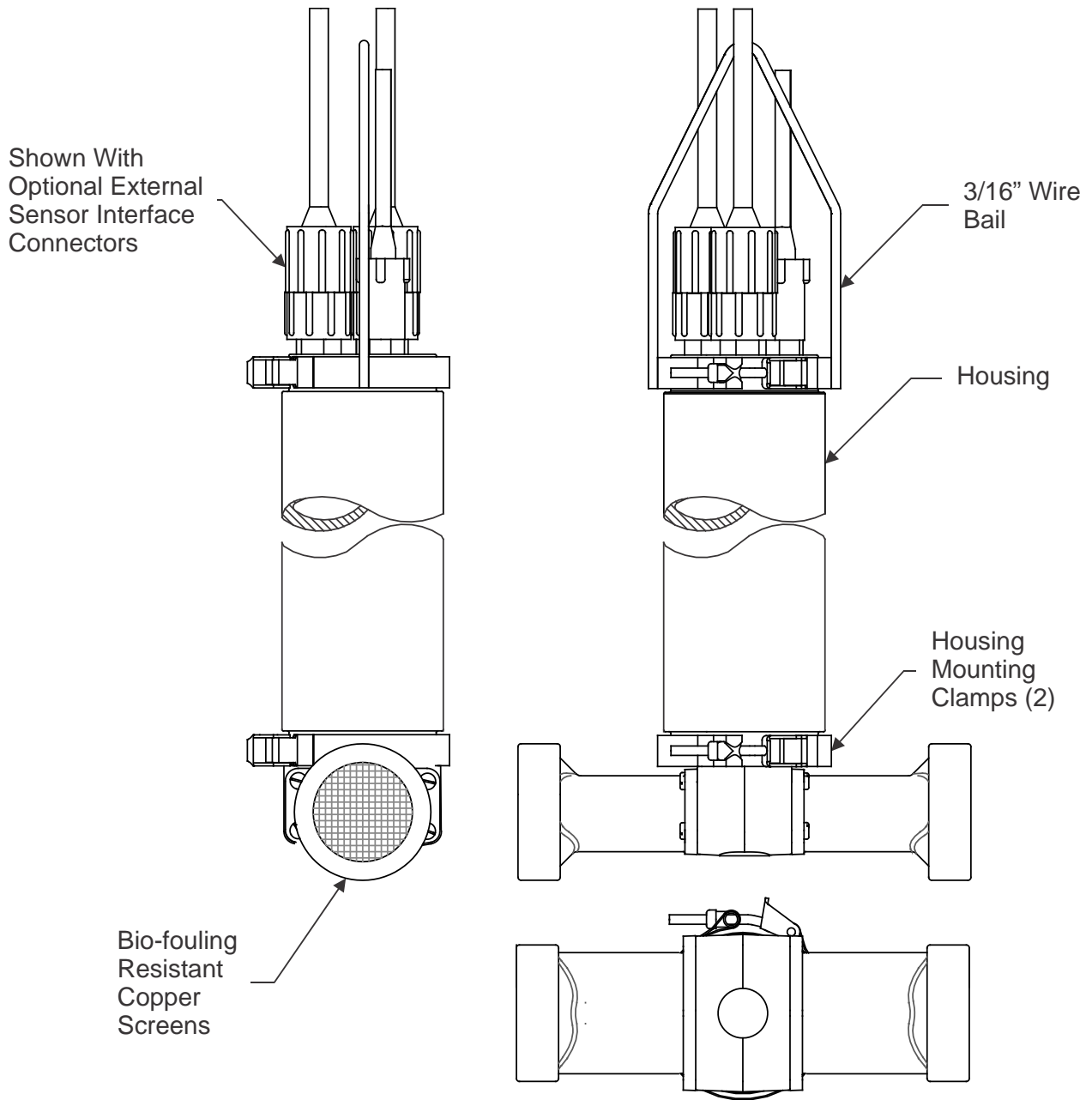

Figure 3. The Location of the CT-NH Main External Components

 **NOTE.** Shown with optional wire bail.

CTD-N Options

Depth Rating – CTD-N units are available with the following depth rating: 500 meter (Delrin housing), 2000 meter (Aluminum housing), or 7000 meter (Titanium housing).

Pressure Sensor – The pressure sensor is available in the following ranges (in meters): 20, 100, 200, 350, 500, 667, 1000, 2000, 3000 or 7000.

Vertical - The CT-NV and CTD-NV conductivity sensor is free flushing with no exposed electrodes that can foul or external fields that can affect calibration. The temperature sensor is directly in the water flow path of the conductivity sensor.

Horizontal – The CT-NH and CTD-NH models have a horizontal head with copper screens to prevent biofouling to build up on the sensors.

Communications Port – The bulk head connector can be configured for the following communications: RS-232, RS-485, or CMOS. See [Communication Interfaces](#) for more information.

External Sensor Interface – The Option 1 and Option 2 connectors are used to connect to optional external sensors. See [APPENDIX C: Optional Sensors](#) for more information.

Battery Pack – An internal alkaline battery pack is used to power the CTD-N when the instrument is deployed autonomously. The battery pack comprises 16 welded alkaline "C" size cells.



NOTE. CTD options must be defined at time of order.

CTD-N part numbers use a seven field code - 111-22-3-444444-5555-6666-7.

Field 1	Field 2	Field 3	Field 4						Field 5	Field 6	Field 7
Family Conductivity / Temperature / Depth	Inductive Technology Type NV = NXIC Vertical NH = NXIC Horizontal	External Sensor Interface	Bit 1 = DR (No Battery) / SC (Battery)	Bit 2 = Board Electronics Type	Bit 3 = Hardware Interface Type	Bit 4 = Communications Type	Bit 5 = Housing Depth Rating (meters)	Bit 6 = Stem Length	Field 5 = Depth Rating of Conductivity (meters)	Field 6 = Press Sensor Option (meters)	Field 7 = OEM Temperature Probe Mounting Position
CT	NV	0 = None	0 = DR	0 = NXIC	0 = N/A	0 = CMOS (TTL)	0 = None	0 = N/A	0 = No Cond	0 = None	0 = N/A
CTD	NH	1 = Yes	B = SC			1 = RS232	1 = 500		500	20	
						2 = RS485	2 = 2000		7000	100	
							3 = 7000			200	
										350	
										500	
										667	
										1000	
										2000	
										3000	
										7000	

Example: CTD-NH-0-000110-500-500-0 corresponds to a CTD, NXIC Horizontal, DR, RS232, 500 meter Conductivity cell, 500 m Housing, 500 m Pressure Sensor.

Specifications

Below are the general specifications for the CTD-N along with the specifications for the conductivity, temperature, and pressure sensors.



NOTE. These specifications are subject to change without notice.

General

Power requirements:	Internal battery pack or 7–35 VDC @ 500 mA maximum when externally powered
External sensor power:	11 VDC nominal @ 50 mA maximum for any sensor; 150 mA maximum total for all the sensors
Depth rating:	500 m standard, Delrin housing 7000 m optional, 64-AVL titanium housing
Sample rate:	1–15 S/sec, selectable
Resolution:	20 bits
Bulkhead connector:	Subconn MCBH4F, mates with MCIL4M (Direct Reading unit) Subconn MCBH6F, mates with MCIL6M (Battery powered and External Sensor Interface units)
Real time clock:	Programmable alarm/sleep functions
Real time clock stability:	±5 ppm initial accuracy, ±12 ppm/year
Communication interface:	RS-232, RS-485 or CMOS TTL
Baud rate:	1200, 9600, 19200, 38400, 57600, and 115200
Data format:	8 data bits, 1 stop bit
Salinity calculation:	The seawater salinity in accordance to PSS78 (Practical Salinity Scale 1978)
Sound velocity calculation:	UNESCO44
Warm up:	3 seconds after power up
Internal memory:	256 MB (standard)
Battery pack:	16 welded alkaline "C" cells; 3.2 V (nominal) at 40 A·h
Storage Temperature	Storage Temperature (Without Batteries) -30° C to 60° C

Conductivity

Sensor type:	Non-external inductive cell
Operational Range:	0 to 70 mS/cm
Typical Accuracy: ^{1,2}	±0.003 mS/cm @ 35 PSU, 22°C
Typical Drift: ^{1,2,3}	±0.001 mS/cm/month
Thermal Stability: ⁴	±.003 mS/cm/°C; Δ°C rel. to 22 °C (typical)
Resolution:	0.0001 mS/cm

¹Specified at 22°C and 35PSU - Defined as the root sum of the squares (RSS) of endpoint non-linearity, repeatability error and calibration uncertainty.

²Specified from 0-70 mS/cm

³Over 1 year (Typical)

⁴ΔT rel. to 22°C (Typical)

Temperature

Sensor type:	Aged thermistor
Range:	-5 to 35 °C
Accuracy:	±0.005°C
Stability:	±0.0005°C/month
Resolution:	0.0001°C
Response:	100 msec

Pressure

Sensor type:	Precision micro-machined silicon transducer
Range:	Customer specified
Accuracy:	±0.05% of full scale
Stability:	±0.004% of full scale/month
Resolution:	0.001% of full scale
Response:	25 msec

Outline Installation Drawings

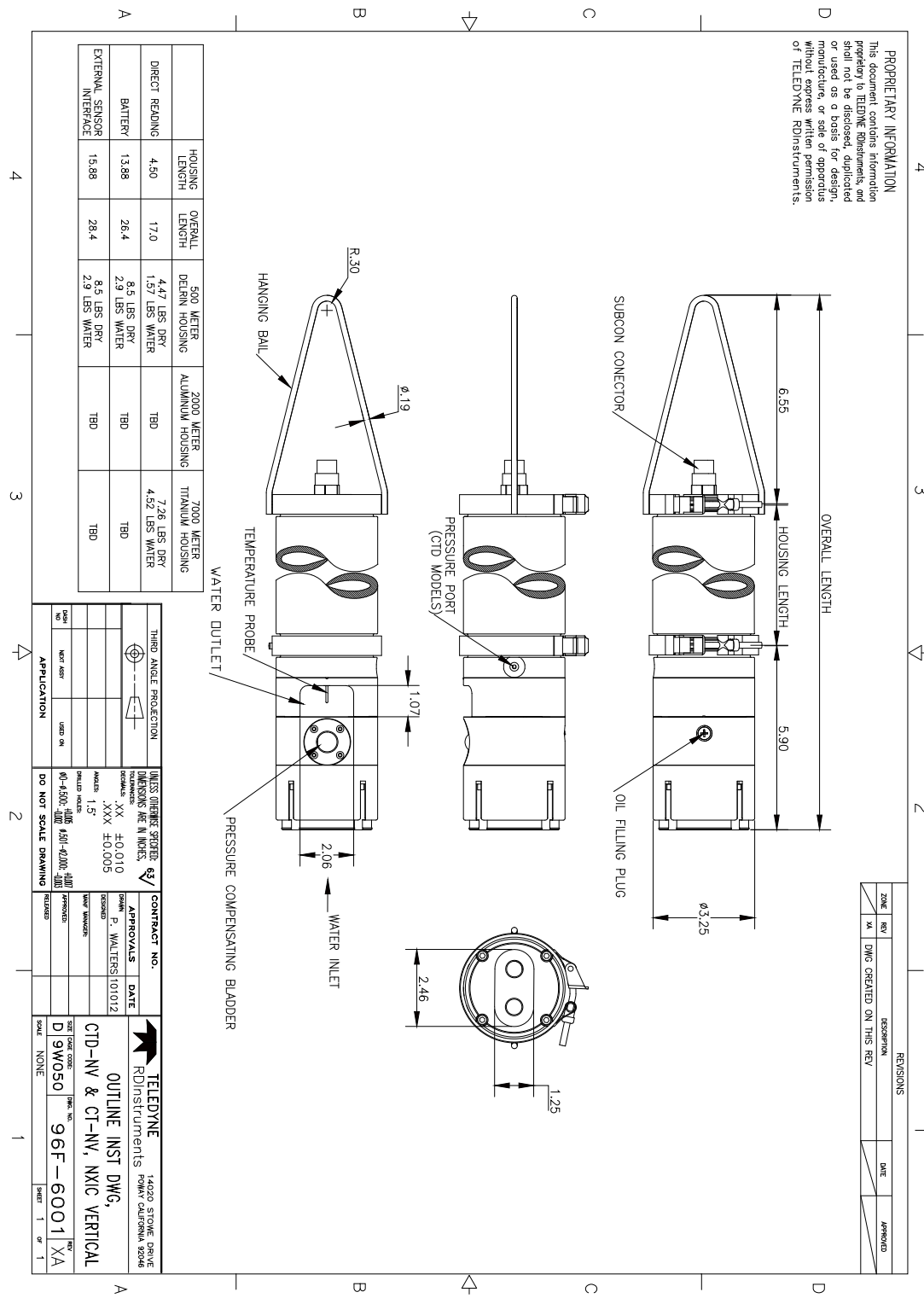

Figure 4. Outline Installation Drawing, CTD-NV & CT-NV, NXIC Vertical

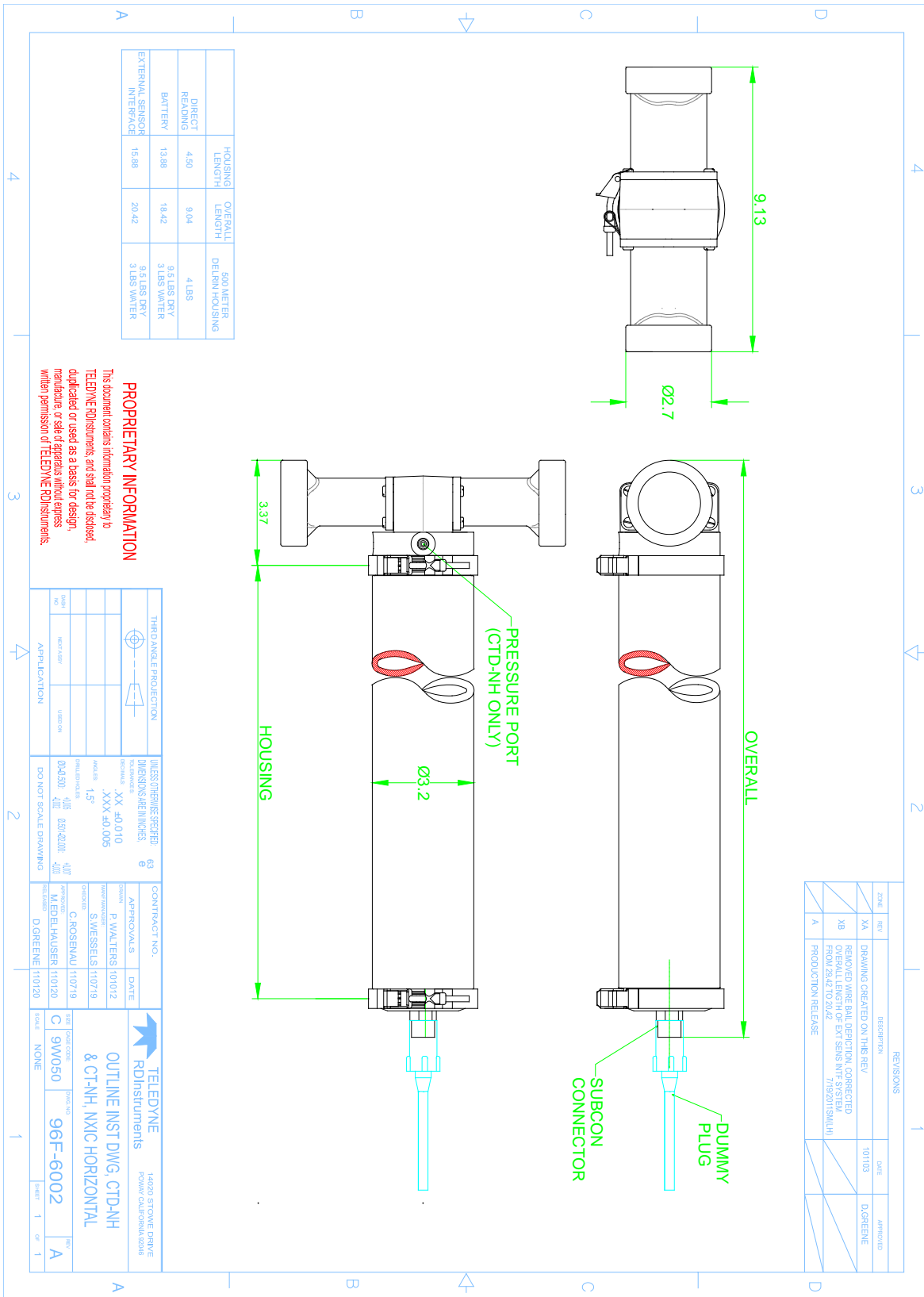

Figure 5. Outline Installation Drawing, CTD-NH & CT-NH, NXIC Horizontal

Unpacking the CTD-N and Connecting It to Your Computer

Before deploying a CTD-N, it must be connected to an available serial port of a computer running CTDPro and configured for deployment. It is also required to connect the instrument to the computer when downloading data. The default serial port that CTDPro uses is COM1, and the default baud rate is 9600 bits/sec. However, any serial port from COM1 to COM16 can be used, and baud rates of 1200 and 19200–115200 bits/sec are additionally available. This section provides instructions on how to unpack the CTD-N and connect it to your computer using an RS-232 or RS-485 interface, how to install and start CTDPro on your computer, how to change the serial port that CTDPro uses, and how to change the baud rate at which the computer and instrument communicate.

Unpacking the CTD-N

Before unpacking the CTD-N, check the shipping container for signs of external damage. If the container appears damaged, report the damage to TRDI and to the freight carrier.

When unpacking the CTD-N, inspect all the items for any apparent damage and verify that all the items listed in the packing list are included in the shipment. Report any damage or missing items to TRDI.

Battery Pack

An internal alkaline battery pack is used to power the CTD-N when the instrument is deployed autonomously. However, if a battery pack was ordered with the CTD-N, it will *not* be installed to prevent possible damage to the instrument from an unexpected battery discharge. The battery pack comprises 16 welded alkaline "C" size cells.



NOTE. Although a battery pack is required for an autonomous deployment, it is not required when configuring the CTD-N.

Standard Items

The following items are included with the shipment of a CTD-N:

- CTD-N instrument
- CTDPro software
- This manual
- Bottle brush (for cleaning the conductivity cells)
- Test cable with power supply and AC line cord
- Spare Anodes

Self-Contained Units:

- Dummy connector and locking sleeve
- Spare O-rings
- Spare mounting hardware
- Alkaline battery pack

Direct Reading Units

- Pigtail and locking sleeve

NH Units

- Spare antifouling screens
- Spare PVC collars for antifouling screens

Optional Items

Optional items typically include the following:

- Additional test cable
- RS-485/RS-232 converter
- Additional alkaline battery pack

These items are available from TRDI and are listed with their part numbers in Table 1 below. See [Customer Service](#) for information on how to contact TRDI to order any of these items.

Table 1: Optional Items Available from TRDI

ITEM	TRDI PART NUMBER
Test Cable	NXIC-OP-CAB-PWR
RS-485/RS-232 Converter	3201-RS232-485
Alkaline Battery Pack	B176-030



NOTE. Spares kits are also available from TRDI. Contact TRDI for more information on these items.

Installing CTDPro and Selecting the CTD-N

The CTD-N is configured using the CTDPro software which must be installed on the computer to which the instrument will be connected. In addition, you must start CTDPro and select the CTD-N or verify that it is already selected. Once selected the CTD-N remains selected until changed.

Installing CTDPro

To install CTDPro:

1. Insert the CTD Documentation and Software CD into your CD-ROM drive. If the CD browser does not appear, navigate to the drive containing the CD and double-click on *Launch.exe*.
2. Click on the **CTD Products** button.

3. Click on the **CTD-N** button and then click on the **CTDPro Software** button. This will start the software installation.

Selecting the CTD-N

To select the CTD-N:

1. Choose Start > All Programs > RD Instruments > CTDPro.

CTDPro starts and the CTDPro Main window opens.

2. Choose File > Properties.

The Properties dialog box shown in Figure 6 opens.

3. In the Properties dialog box, select CTD-N from the Product drop-down list box, and then click OK.

The Properties dialog box closes, the CTD-N is selected, and the CTD menu appears in the menu bar to the right of the File menu in the CTDPro Main window.

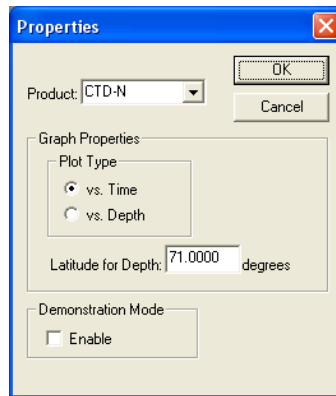

Figure 6. The Properties Dialog Box

Communication Interfaces

The CTD-N includes three communications interfaces for configuring and downloading data from the instrument. The instrument was prewired from the factory for RS-232, RS485 or CMOS (TTL) digital depending on what was specified at the time of order. The serial tag on the instrument identifies which communications interface is factory installed. For instructions on how to change the wiring for an interface other than what was factory installed, contact TRDI. See [Customer Service](#) for information on how to contact TRDI.

RS-232 Interface

The RS-232 serial interface requires that your computer provide true RS-232 data levels. Some older laptop computers do not support the negative output voltages provided by the RS-232 standard and these computers may not work properly with the instrument.

RS-485 Interface Option

Systems ordered with an RS485 are capable only of RS485 communication and will require use of an external RS485/RS232 converter for communication with a computer. A converter can be ordered separately from TRDI or procured independently.

CMOS Interface Option

The optional CMOS serial interface provides TTL level signal outputs. Consult TRDI directly for more information about this option.

Connecting the CTD-N to Your Computer

The following items are required to connect a CTD-N to your computer:

- Test cable with power supply and AC line cord
- RS-485/RS-232 converter, for RS-485 interface connection only
- An available serial port on the computer



NOTE. If you will be fabricating your own cable for connecting the CTD-N to your computer, see [APPENDIX B: Bulkhead Connector Wiring](#) for information on the CTD-N bulkhead connector components and wiring.



NOTE. Although any serial port from COM1 to COM16 can be used, use COM1 if it is available, as it is the default serial port setting of CTDPro. If you use any other serial port, you must select it in CTDPro as described in [Changing the Serial Port](#).

Connecting to the RS-232 Interface

A CTD-N with an RS-232 interface is shown set up with a laptop computer in Figure 7.

To connect a CTD-N with an RS-232 interface to your computer:

1. Disconnect the dummy connector from the bulkhead connector on the instrument.
2. Connect the test cable to the bulkhead connector on the instrument and to the serial port on your computer.
3. Connect the power supply to the POWER connector on the test cable.
4. Connect the AC line cord to the power supply and to a 110–240 VAC, 50–60 Hz power source.

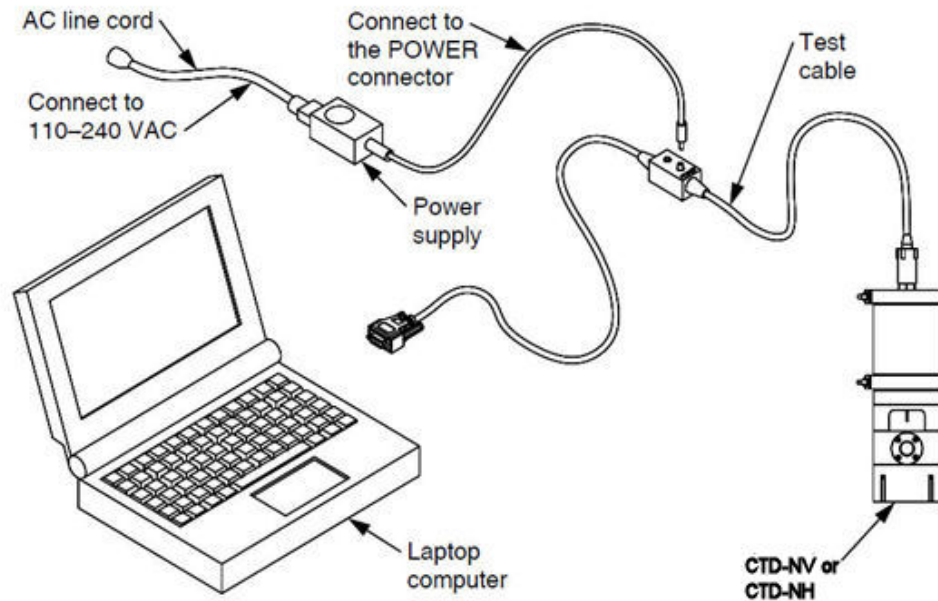

Figure 7. CTD-N Setup—with RS-232 Interface

Using the CTD-N End Cap Switch

In a standard CTD-N, the battery is always powered. The CTD-N Battery Switch End cap allows the user to manually remove power when the unit is in between uses. This switch can only be used in the following modes; Auto Logging on power up, Battery End cap Enabled interval, or Battery End cap Enabled – Delayed Start interval.



NOTE. The battery must always be removed whenever the unit is being shipped or stored for long periods.

The CTD-N End Cap Switch disconnects the battery without the need to open the unit. A special 6-pin battery power-shorting plug is provided to apply power to the CTD-N. Unplugging the shorting plug disconnects the battery. An adaptor cable is supplied so that the standard test cable can still be used.

Connecting a PC to the CTD-N with an End cap Switch

A NXIC CTD with an End cap Switch is shown set up with a laptop computer in Figure 8. To connect a NXIC CTD with your computer, use the adaptor cable B176-207.



CAUTION. The adaptor cable will use battery power when there is no external power supply.

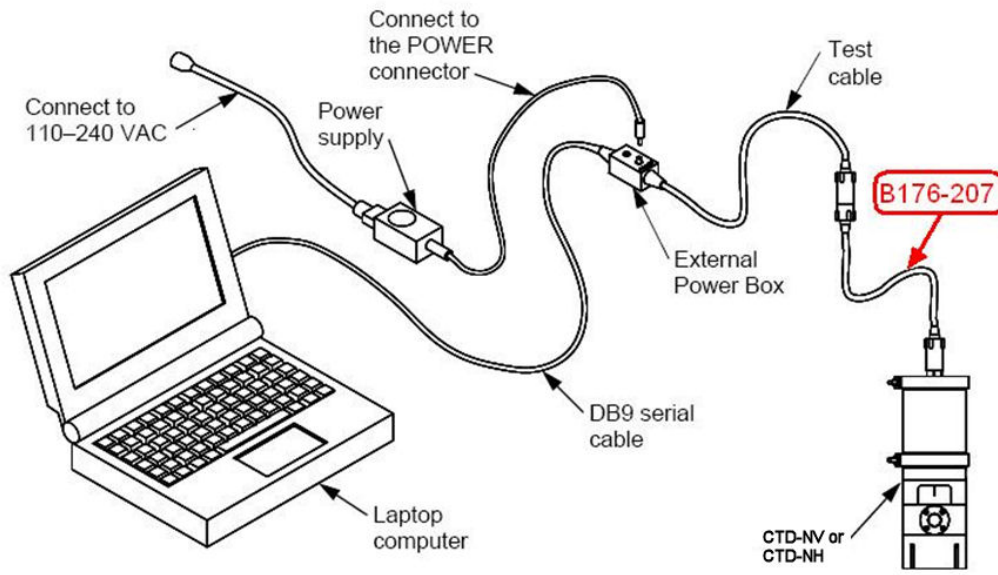

Figure 8. CTD-N Setup with B176-207 Battery Adapter Cable

Connecting to the RS-485 Interface

A CTD-N with an RS-485 interface is shown set up with a laptop computer in Figure 9.

To connect a CTD-N with an RS-485 interface to your computer:

1. Disconnect the dummy connector from the bulkhead connector on the instrument.
2. Connect the test cable to the bulkhead connector on the instrument and to the RS-485 connector of the RS-485/RS-232 converter.

For those customers who order an RS485-RS232 converter from us, we ship a B&B Electronics Model 4WSD9R, which is a powered converter also capable of RS422/RS232 conversion that is configured with four dip switches.

RS-422	-	RS-485
Echo On	-	Echo Off
4 Wire	-	2 Wire
4 Wire	-	2 Wire

To work properly with our test setup, the dip switches should be set to:

- ➔ RS-485
- ➔ Echo Off
- ➔ 2 Wire
- ➔ 2 Wire

3. Connect the RS-232 connector of the RS-485/RS-232 converter to the serial port on your computer.
4. Connect the power supply to the POWER connector on the test cable.

5. Connect the AC line cord to the power supply and to a 110–240 VAC, 50–60 Hz power source.

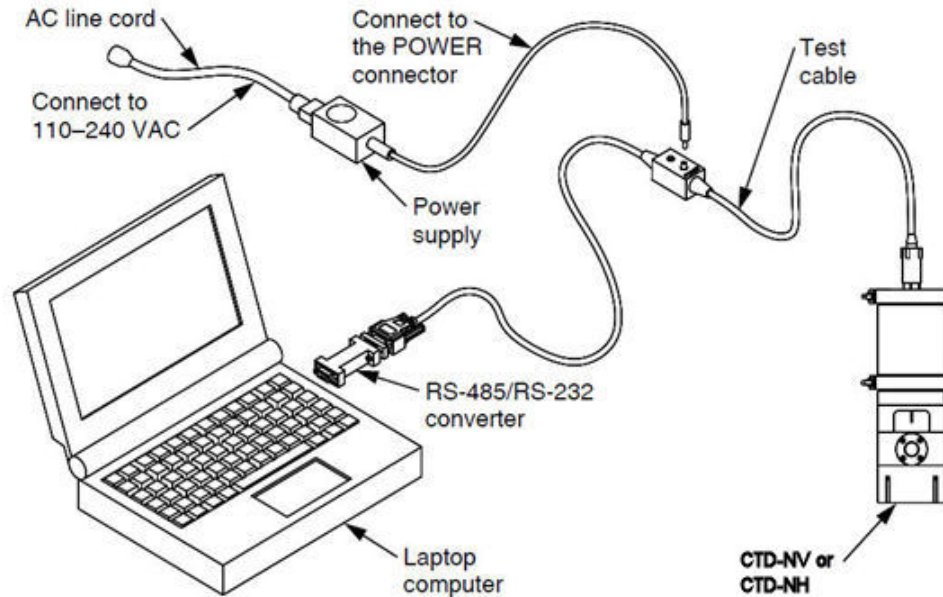

Figure 9. CTD-N Setup—with RS-485 Interface

Changing the Serial Port

The default serial port for CTDPro is COM1. However, any one of 16 serial ports from COM1 to COM16 can be selected.



NOTE. For Windows 7® computers, only COM port 1 is supported.

To change the serial port:

1. Choose Start > All Programs > RD Instruments > CTDPro.

CTDPro starts and the CTDPro Main window opens.

2. Choose CTD > Communications > Setup.

The Communication Properties dialog box shown in Figure 10 opens.

3. Enter the new serial port number in the Comport Number text box.



CAUTION. Do not change the baud rate from 9600. See [Changing the Baud Rate](#) for instructions on how to change the baud rate of the CTD-N and the serial port to which it is connected.

4. Click OK to save the new serial port selection and close the Communication Properties dialog box.

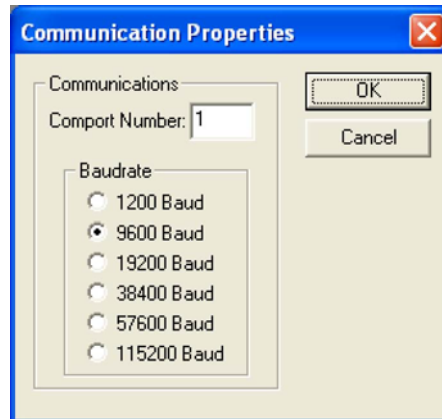

Figure 10. The Communication Properties Dialog Box

Changing the Baud Rate

The default baud rate for the CTD-N and CTDPro is 9600 bits/sec with one stop bit, eight data bits and no parity. However, you can use CTDPro to change the baud rate at which the computer and the instrument communicate in the following three ways:

[Change the baud rate of the serial port](#) where CTDPro changes the baud rate of the computer's serial port to the selected baud rate without affecting the baud rate of the CTD-N. This allows communications with multiple instruments, each of which have different baud rates. The baud rates of the instruments must be known.

[Automatically change the baud rate of the serial port to the baud rate of the CTD-N](#) where CTDPro automatically determines the baud rate of the instrument and then changes the baud rate of the computer's serial port to the same. The baud rate of the instrument is not changed. This allows communications with the instrument without knowing its baud rate.

[Change the baud rate of the CTD-N and the serial port](#) where CTDPro first changes the baud rate of the CTD-N to the selected baud rate and then automatically changes the baud rate of the computer's serial port to the same. This allows communications with an instrument at any of the available baud rates. The baud rate of the instrument remains changed.

Changing the Baud Rate of the Serial Port

To change the baud rate of the serial port:

1. Choose Start > All Programs > RD Instruments > CTDPro.

CTDPro starts and the CTDPro Main window opens.

2. Choose CTD > Communications > Setup.

The Communication Properties dialog box shown in Figure 10 opens.

3. In the Baudrate area of the Communication Properties dialog box, select the baud rate.
4. Click OK to save the new baud rate selection and close the Communication Properties dialog box.

Automatically Changing the Baud Rate of the Serial Port to the Baud Rate of the CTD-N

To automatically change the baud rate of the serial port to the baud rate of the CTD-N:

1. Choose Start > All Programs > RD Instruments > CTDPro.

CTDPro starts and the CTDPro Main window opens.

2. Choose CTD > Communications > Find CTD.

CTDPro determines the baud rate of the instrument and then changes the baud rate of the serial port to the same. When changed, the Found CTD-N window opens confirming the serial port to which the instrument is connected and the selected baud rate:

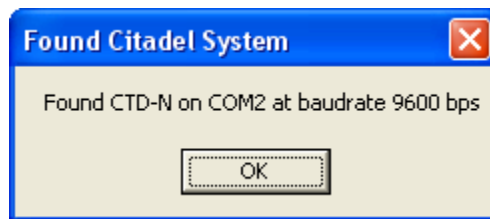

3. Click OK in the Found CTD-N window to close the window.

Changing the Baud Rate of the CTD-N and the Serial Port

To change the baud rate of the CTD-N and the serial port:

1. Choose Start > All Programs > RD Instruments > CTDPro.

CTDPro starts and the CTDPro Main window opens.

2. Choose CTD > Communications > Settings.

The Communication Rate dialog box shown in Figure 11 opens.

3. In the Baudrate area of the Communication Rate dialog box, select the baud rate.

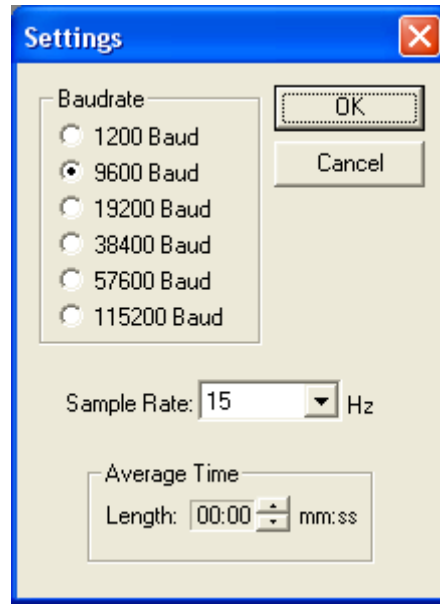

Figure 11. The Communication Rate Dialog Box

4. Click OK to save the baud rate selection and close the Communication Rate dialog box.

Connecting and Setting up Communications with a GPS

If you have a global positioning system (GPS), you can connect it to your computer. With the GPS connected you can have CTDPro include the latitude, longitude, and time of day with the data. A NEMA GPGGA string is required.

To connect a GPS connect the RS-232 output of the GPS to an available serial port on your computer. Once connected, you can set up communications with the GPS.

To set up communications with a GPS:

1. Choose Start > All Programs > RD Instruments > CTDPro.

CTDPro starts and the CTDPro Main window opens.

2. Choose NAV > Setup.

The Navigation Setup dialog box shown in Figure 12 opens.

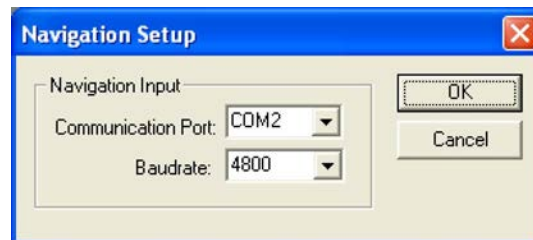

Figure 12. The Navigation Setup Dialog Box

3. Select the serial port to which the GPS is connected from the Communication Port drop-down list box.
4. Select the baud rate for the serial port from the Baudrate drop-down list box. The default baud rate is 4800 bits/sec and is typically the baud rate used.
5. Click OK to save the settings and close the Navigation Setup dialog box.

Checking, Configuring, & Deploying the CTD-N

You can configure and deploy the CTD-N under its own internal battery power and store all the data in the instrument's internal memory. After recovering the instrument, you can retrieve and save the data. This section describes the configuration settings for the CTD-N and provides instructions on how to perform some pre-deployment checks and how to configure and deploy the CTD-N in each of four different running modes. In addition, instructions are provided on how to select from some available communications options that affect the operation of the instrument and the data output format.



NOTE. Before you can configure the CTD-N, you must select it in CTDPro as described in [Selecting the CTD-N](#). The CTD menu will not be displayed unless the CTD-N is selected.

CTD-N Configuration Settings

Configuring the CTD-N requires that you make the following settings:

- Select the running mode.
- Select the instrument run times, if required.
- Select whether to average the data.
- Select the instrument sampling rate.
- Reset the local time and date.

The CTD-N is configured from the CTD-N Configuration dialog box when deploying the instrument as described in [Configuring and Deploying the CTD-N](#). The CTD-N Configuration dialog box is shown in Figure 13 and is opened by choosing CTD > Configure and Deploy. The CTD-N Configuration dialog box also displays the serial number and the time and date settings of the connected instrument. The time and date settings can be reset directly from the dialog box to that of the connected computer.

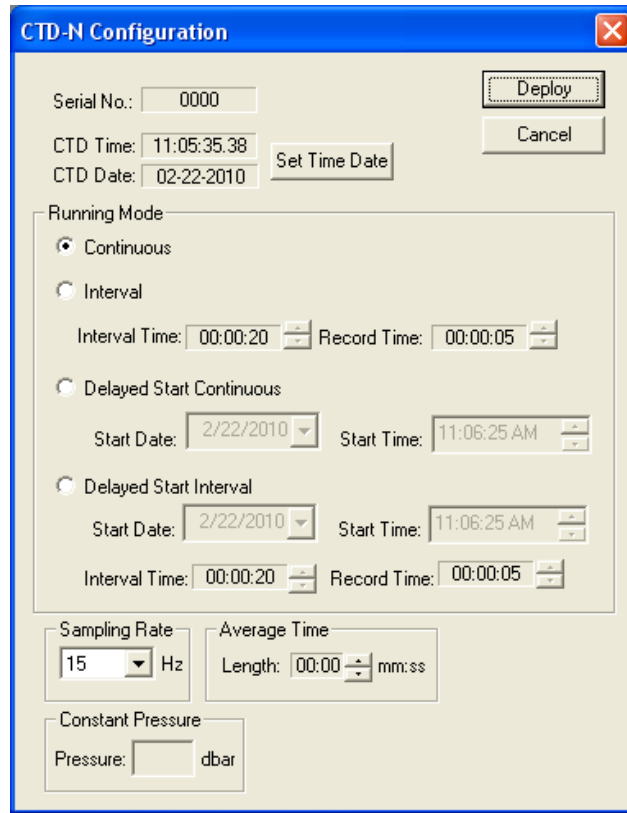

Figure 13. The CTD-N Configuration Dialog Box

Running Modes

There are four running modes for acquiring and storing data:

Continuous mode is where data are continuously acquired and stored at the selected sampling rate. This mode is recommended only for short deployments as it quickly depletes the battery pack and fills memory.

Interval mode is where data are acquired and stored at the selected sampling rate for specified periods—the Record Time, at repeated intervals—the Interval Time.

Delayed Start Continuous mode is similar to Continuous mode, but where the instrument begins acquiring and storing data at a future date and time—the Start Date and Start Time. This mode allows the instrument to be set up on shore, after which data are not collected until the specified time and date.

Delayed Start Interval mode is similar to Interval mode, but where the instrument begins acquiring and storing data at a future date and time—the Start Date and Start Time. This mode allows the instrument to be set up on shore, after which data are not collected until the specified time and date.

The running mode is selected in the Running Mode area of the CTD-N Configuration dialog box.

A run time diagram that illustrates one Interval Time cycle is shown in Figure 14. The Interval Time and Record Time are entered in the Running Mode area of the CTD-N Configuration dialog box in the following scroll boxes:

Interval Time:	The time in hours, minutes, and seconds between the start of each Record Time.
Record Time:	The time in hours, minutes and seconds beginning at the start of each Interval Time during which the instrument is on and collecting data.



NOTE. The Record Time must be less than the Interval Time.

The Start Date and Start Time are entered in the Running Mode area in the following scroll boxes:

Start Date:	The date as the month, day, and year on which the instrument will turn on and begin collecting data at the Start Time.
Start Time:	The time in hours, minutes and seconds, and AM or PM, at which the instrument will turn on and begin collecting data on the Start Date.

Averaged Data

To save memory, data that are collected continuously or during the Record Time can be averaged over a specified interval - the Average Time. The Average Time is entered in minutes, and seconds in the Length scroll box, which is in the Average Time area of the CTD-N Configuration dialog box. Average Times are shown in the run time diagram in Figure 14. The minimum Average Time is 5 seconds; the maximum, 59 minutes, 59 seconds. Enter 4 seconds or less for no averaging.



NOTE. When running in Interval or Delayed Interval mode, the Average Time should be set to an integer number that is evenly divisible into the Record Time. For example, if the Record Time is 10 minutes, the Average Time should be set to 1, 2, 5, or 10 minutes. Otherwise the last Average Time in each interval will be automatically shortened.

Sampling Rate

The CTD-N sampling rate is selected in the Sampling Rate area of the CTD-N Configuration dialog box. The sampling rate determines the frequency at which the CTD-N measures and stores the data. There are 15 sampling rates, 1 Hz through 15 Hz in 1-Hz increments.



NOTE. The faster the sampling rate the faster the available memory will be filled.

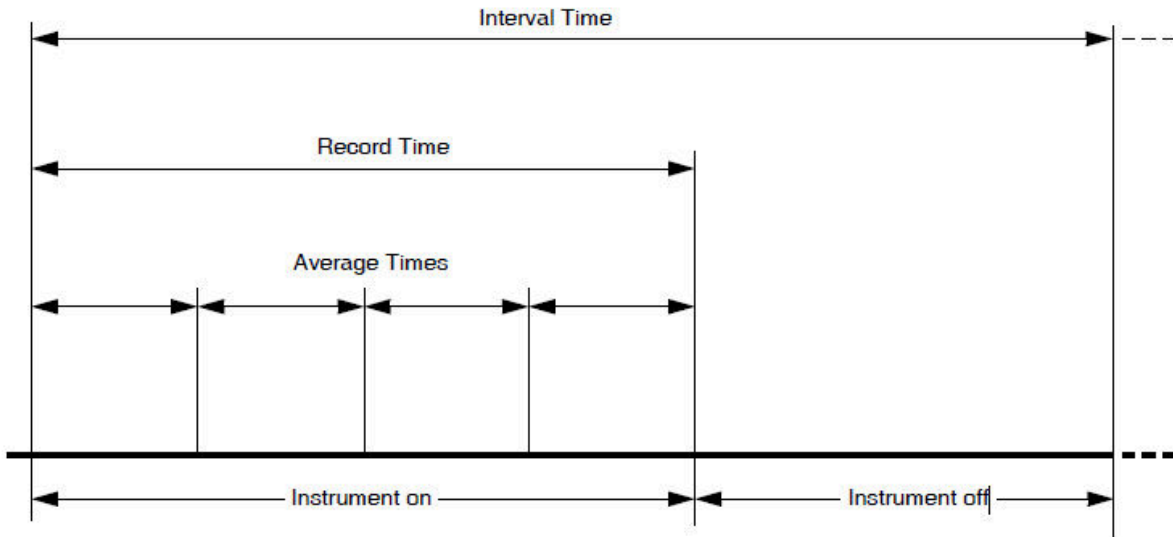

Figure 14. Run Time Diagram, Including Average Times, for One Interval Time Cycle

Time and Date

The CTD-N time and date are displayed in the CTD Time and CTD Date displays in the CTD-N Configuration dialog box. The time and date can be reset at any time to that of the computer on which CTDPro is running by clicking Set Time Date.

Serial Number

The serial number of the CTD-N is displayed in the Serial No. display in the CTD-N Configuration dialog box and is acquired directly from the instrument.

Communications Options

Communications options can be selected in the Advanced Settings dialog box shown in Figure 15. To open the Advanced Settings dialog box, choose CTD > Communications > Advanced Settings.

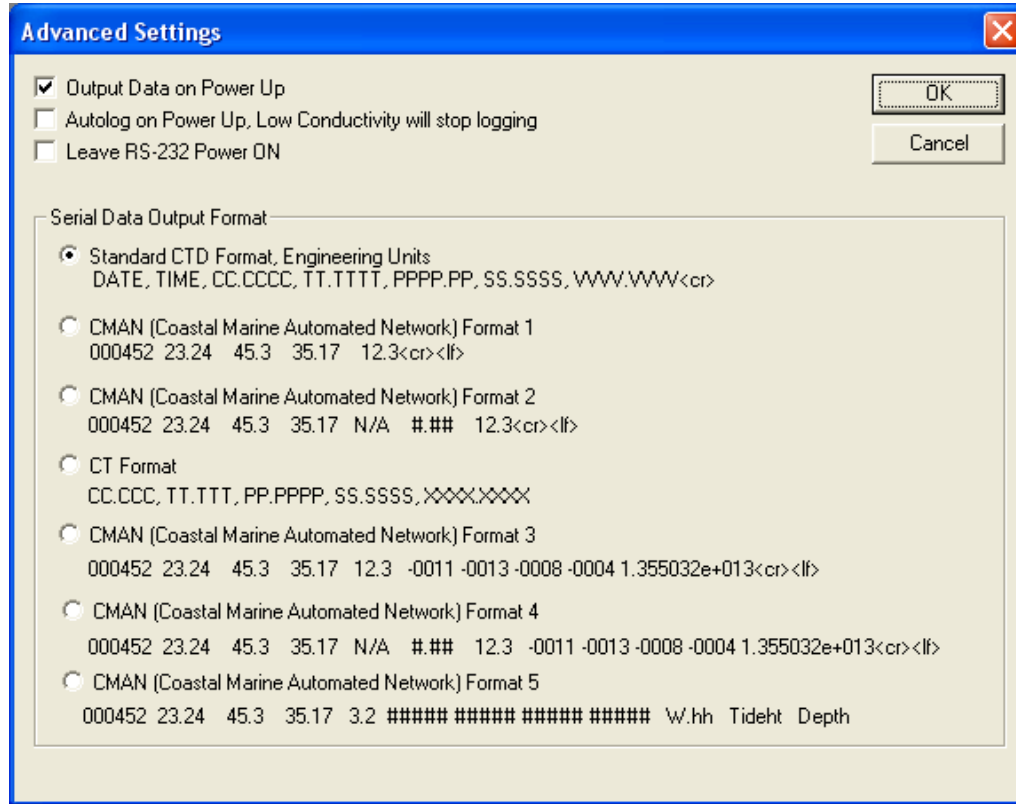

Figure 15. The Advanced Settings Dialog Box

The Advanced Settings dialog box allows you to modify the standard operation of the CTD-N, including some hardware functions and the data output format. After making the selections, click OK to save the selections and close the Advanced Setting dialog box.

The hardware functions that can be modified are the following:

Output Data on Power Up causes the instrument to immediately output data when power is applied.

Autolog on Power Up, Low Conductivity will stop logging causes the instrument to begin recording data when power is applied and stop recording data when conductivity is below a specified threshold. This feature allows continuous, multiple casts to be made. See [NXIC CTD Autolog Feature](#) for details.

Leave RS-232 Power ON ensures the instrument will function properly with RTS/CTS handshaking.

The data output format selections are the following:

Standard CTD Format, Engineering Units uses standard CTD data output formatting.

CMAN (Coastal Marine Automated Network) Format 1 uses CMAN Format 1 formatting.

CMAN (Coastal Marine Automated Network) Format 2 uses CMAN Format 2 formatting.

CT Format uses standard CT data output formatting.

CMAN (Coastal Marine Automated Network) Format 3 uses CMAN Format 3 formatting.

CMAN (Coastal Marine Automated Network) Format 4 uses CMAN Format 4 formatting.

CMAN (Coastal Marine Automated Network) Format 5 uses CMAN Format 5 formatting.

Predeployment Checks

Before configuring and deploying the CTD-N, you should perform some predeployment checks. These checks comprise verifying adequate battery and memory capacity for the required length of deployment and running the diagnostic tests on the instrument.



NOTE. Diagnostic tests should be done in air in a constant unchanging environment.

Verifying Battery Pack Capacity and Memory Requirements

Before deploying the CTD-N you should verify that the battery pack capacity is sufficient for the intended deployment period and that there is enough memory to store all the data acquired during this period. CTDPro provides an estimator which calculates the available running days based on the selected running mode and the known—or measured—battery pack capacity in the instrument. In addition, the estimator calculates the number of days at which the memory will fill based on the selected running mode and sampling rate. The calculated results are displayed and can be printed and saved to a file.



NOTE. External power must be disconnected to make this measurement effectively. Otherwise, CTDPro will calculate longevity based on the external voltage supply rather than the battery pack itself.

To verify sufficient battery pack capacity and enough memory for a deployment:

1. If you want CTDPro to measure the battery pack capacity in the instrument when calculating the available running days, connect the instrument to your computer.

If you want to enter the battery pack capacity directly to calculate the available running days, you do not have to connect the instrument to your computer.

2. Choose Start > All Programs > RD Instruments > CTDPro.

CTDPro starts and the CTDPro Main window opens.

3. Choose CTD > Battery Life.

The Battery Life dialog box shown in Figure 16 opens.

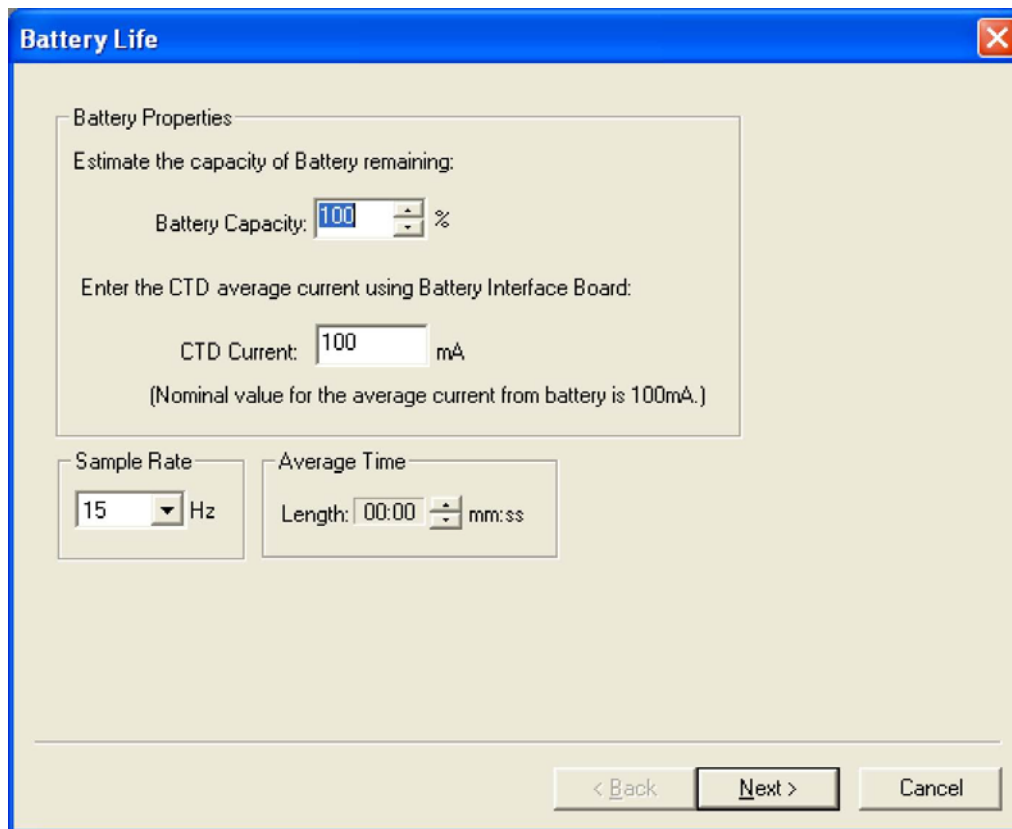

Figure 16. The Battery Life Dialog Box—Entering the Battery Pack Capacity Sample Rate and Average Times

4. If you want to enter the battery pack capacity directly, enter it in percent in the Battery Capacity scroll box in the Battery Properties area of the Battery Life dialog box. Or click the up or down arrow in the scroll box to enter the capacity. Otherwise, if the instrument is connected, you can allow CTDPro to measure and enter the capacity automatically.



CAUTION. Do not enter the measured current drawn from an external power supply in the CTD Current text box. The entry in the CTD Current text box is the average current drawn from an installed battery pack only.



NOTE. The entry in the CTD Current text box normally should not be changed as this value is factory measured. However, if the CTD-N is supplying power to optional external sensors, the entered value should be changed to 32mA plus any 3rd party sensors. If a 0% shows up in the battery capacity, it is not automatically recognizing the battery, this could mean the battery is not connected.

5. If you want to change the measured current drawn by the instrument, enter the current in mA in the CTD Current text box.
6. In the Sample Rate area, select the desired sampling rate in hertz of the instrument from the drop-down list box.

7. In the Average Time area, use the up and down arrows in the Length scroll box to enter the Average Time in minutes and seconds (mm:ss).
8. Click Next.

The Battery Life dialog box shown in Figure 17 opens.

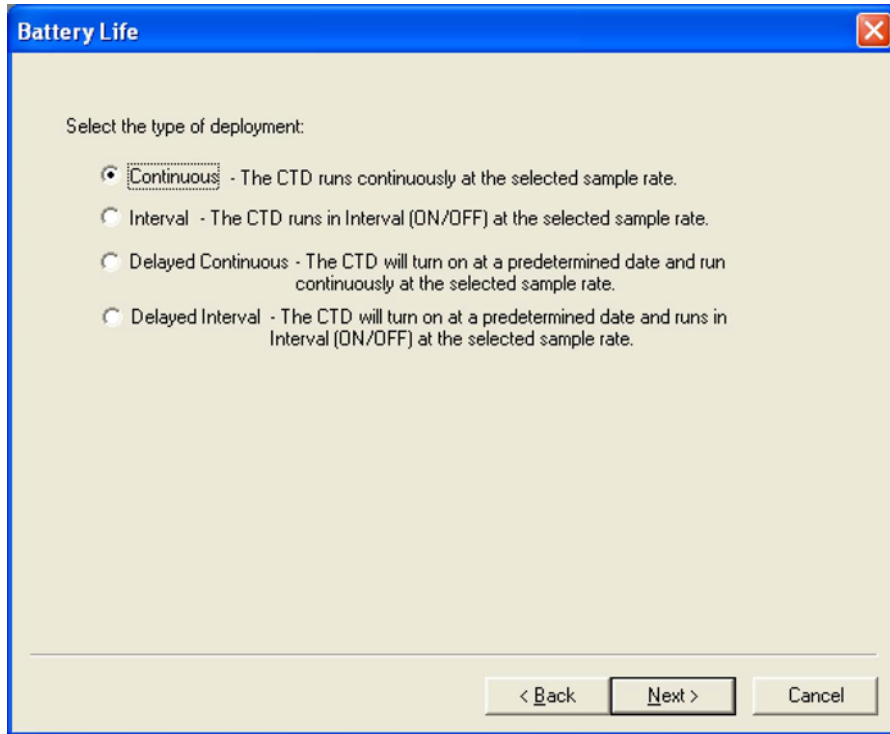

Figure 17. The Battery Life Dialog Box—Selecting the Running Mode

9. Do one of the following:
 - Select Continuous.
 - Select Interval, click Next, and then enter the Interval Time and Record Time.
 - Select Delayed Continuous, click Next, and then enter the Start Date and Start Time.
 - Select Delayed Interval, click Next, and then enter the Interval Time, the Record Time, the Start Date, and the Start Time.
10. Click Next.

The Battery Life dialog box shown in Figure 18 opens displaying the deployment summary, which includes the number of available running days under "BATTERY STATISTICS," the number of days at which memory will fill under "MEMORY STATISTICS," and additional information.

11. To print the information, click Print, select the printer to use, and then click OK.
12. To save the information, click Save.

The Save As dialog box for battery pack information files shown in Figure 19 opens. This dialog box is used to create the file in which to save the battery pack and memory information.

13. Click the arrow in the Save in drop-down list box and select the folder in which to save the battery pack information file.
14. In the File name text box enter the name of the file in which to save the battery pack information. The extension *.txt* is added automatically.
15. Click Save.

The Save As dialog box for battery pack information files closes and the battery pack information is saved to the specified file. The file can be opened in any text editor for viewing and printing.

16. Click Finish.

The Battery Life dialog box closes.

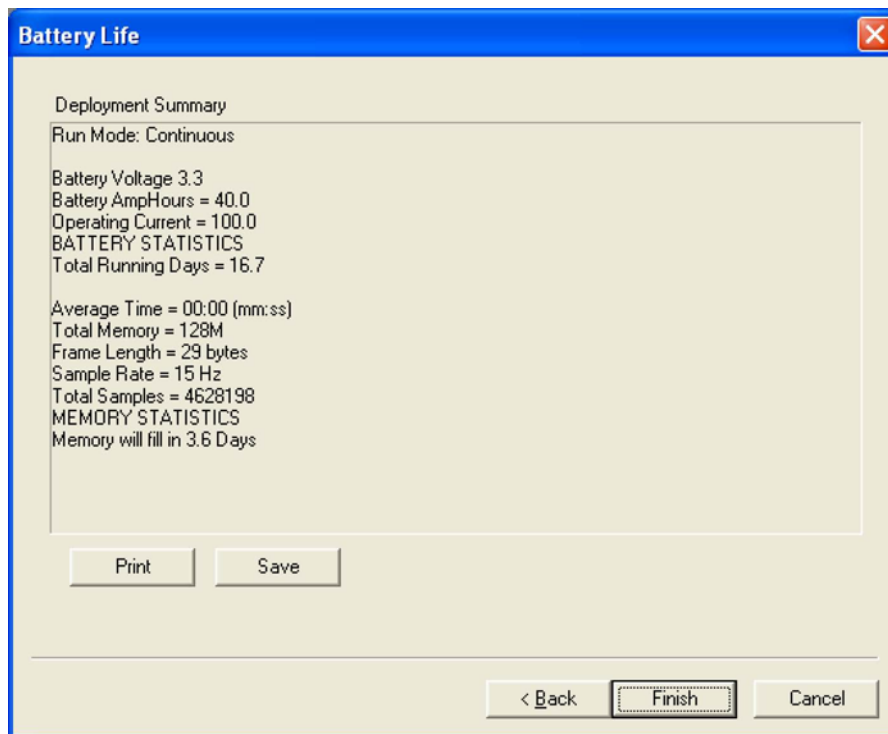

Figure 18. The Battery Life Dialog Box—Deployment Summary

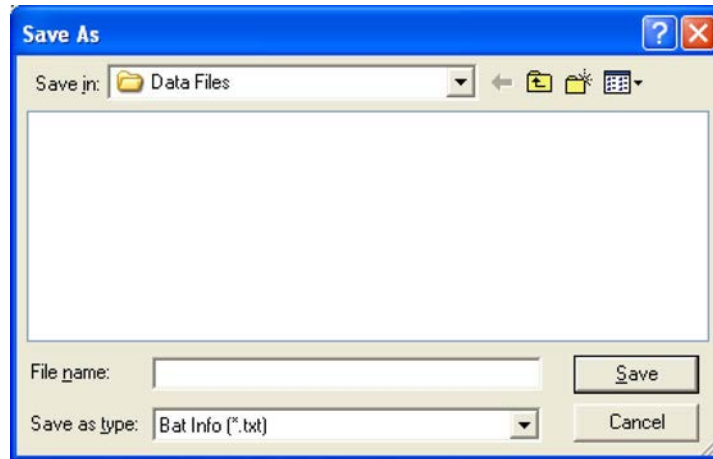

Figure 19. The Save As Dialog Box for Battery Pack Information Files

Running the Diagnostic Tests

Before deploying the CTD-N you should run the diagnostic tests on the instrument. These tests are provided by CTDPro and encompass pass/fail checks of the conductivity, pressure and temperature readings of the analog-to-digital converter (A/D); the conductivity, pressure and temperature data quality; and a number of operational parameters.



NOTE. Diagnostic testing of the CTD-N must be performed in air.

To run the diagnostic tests on the CTD-N and verify calibration of the CTD-N conductivity sensor:

1. Connect the CTD-N to your computer.
2. Choose Start > All Programs > RD Instruments > CTDPro.

CTDPro starts and the CTDPro Main window opens.

3. Choose CTD > Diagnostics.

The Diagnostics dialog box shown in Figure 20 opens and displays, in the CTD Information area, the serial number of the CTD-N and the firmware version that is installed in the instrument.

4. Click Run.

The Save As dialog box for diagnostics data files shown in Figure 21 opens. This dialog box is used to create the file in which to save the diagnostics data.

5. Click the arrow in the Save in drop-down list box and select the folder in which to save the diagnostics data file.
6. In the File name text box enter the name of the file in which to save the diagnostics data. The extension `.txt` is added automatically.



NOTE. Windows 7® will not save any data files to the folder selected in the dialog box. Instead it saves to the desktop by default. This is a known bug that will be addressed in a future release of CTDPro.

7. Click Save.

The Save As dialog box for diagnostics data files closes. CTDPro performs diagnostic testing of the CTD-N and the results are displayed as check marks in the appropriate Pass and Fail check boxes in the A/D Readings, Data Quality and Operation areas of the Diagnostics dialog box as shown in Figure 22 in the Operation area the Internal Supply, Reference and Battery Voltage displays display the measured voltages. In addition, the Status display displays the diagnostics data acquired during testing along with a progress bar indicator.

Figure 20. The Diagnostics Dialog Box

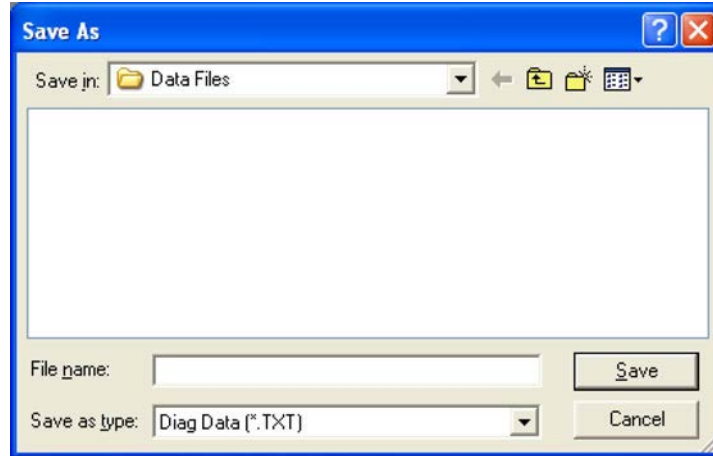

Figure 21. Save As Dialog Box for Diagnostics Data Files

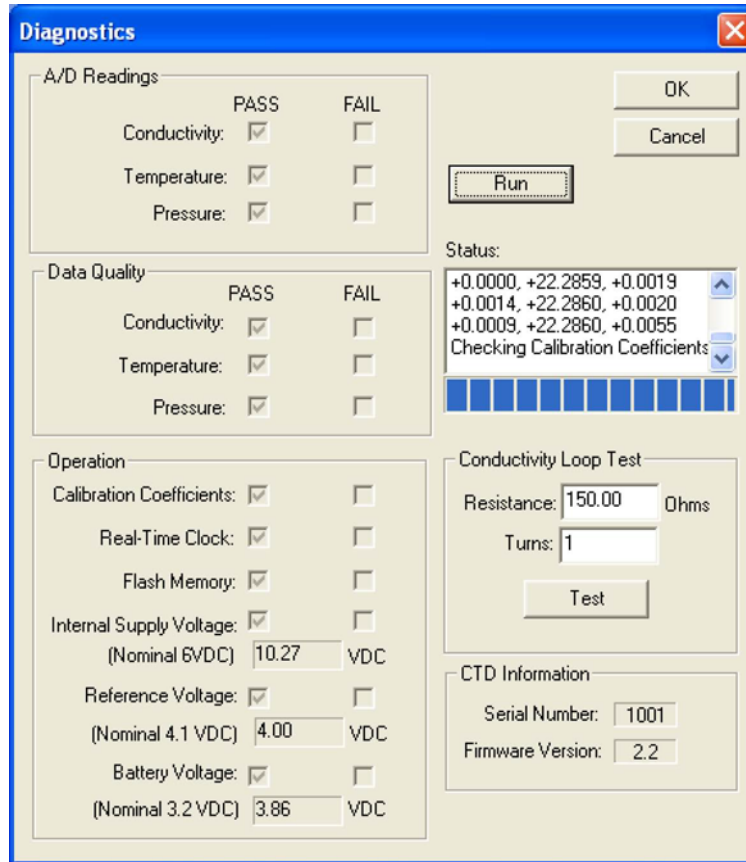

Figure 22. Results of Diagnostic Testing in the Diagnostics Dialog Box

After diagnostic testing is complete, the diagnostics data is saved in the diagnostics data file. The file can later be opened in any text editor for viewing and printing.

8. Note: The Loop Test was partially implemented for long term stability testing of CTDs for factory use, it is not intended as a verification of calibration and should not be used as such. TRDI does not supply or support the resistance test device.
9. Click OK in the Diagnostics dialog box to close it.

Configuring and Deploying the CTD-N

The CTD-N is configured and deployed in one of the four running modes: Continuous, Interval, Delayed Start Continuous, or Delayed Start Interval. In addition, in all modes you can select to average the data over the Average Time.



NOTE. When selecting to average the data, the Average Time should be evenly divisible into the Record Time.

Configuring and Deploying the CTD-N in Continuous Mode

To configure a CTD-N for deployment and to acquire and store data in Continuous mode:

1. If necessary, replace the battery pack in the CTD-N. See [Replacing the Battery Pack](#) for instructions on how to replace the battery pack.



NOTE. Replacing the battery pack will not affect the instrument's configuration, stored data, or time and date settings.

2. Connect the CTD-N to your computer.
3. Choose Start > All Programs > RD Instruments > CTDPro.

CTDPro starts and the CTDPro Main window opens.

4. Choose CTD > Configure and Deploy.

If the CTD-N is currently logging data, a window opens asking if you want to stop logging:

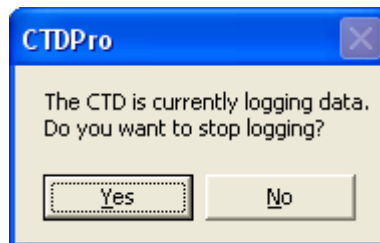

5. Click Yes to stop data logging, or click No to continue.

If you click No, the window closes and data acquisition continues without interruption.

If you click yes, data logging stops, the window closes and the CTD-N Configuration dialog box shown in Figure 13 opens.

6. If the local time and date require setting, click Set Time Date in the CTD-N Configuration dialog box.

The Set Time window opens displaying the time and date as acquired from the computer on which CTDPro is running, along with the difference in time between that of the computer and the instrument.

7. Click OK to save the new time and date and close the Set Time window.

8. In the Running Mode area of the CTD-N Configuration dialog box, select Continuous.
9. In the CTD Sampling Rate area, select the desired sampling rate in hertz of the CTD-N from the drop-down list box.
10. In the Average Time area, use the up and down arrows in the Length scroll box to enter the Average Time in minutes and seconds (mm:ss).
11. Click Deploy.

The Erase Memory window opens:

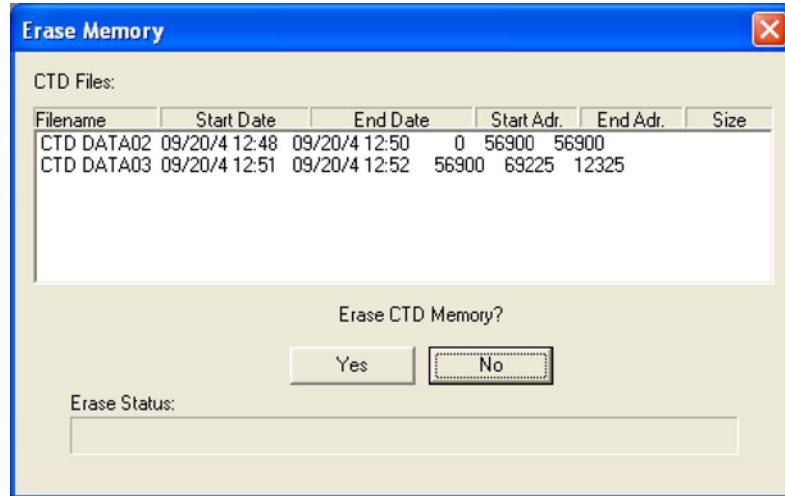

NOTE. Clicking No in the Erase Memory window will append the new data file to the last data file stored in memory. No memory will be erased.

12. To erase all of memory, click Erase.

A CTDPro window opens asking if you want to erase all of memory:

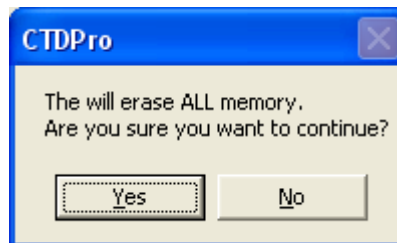

13. Click Yes to confirm that you want to erase all of memory.

The memory is erased as indicated by the Erase Status progress bar in the Erase Memory window, and then the Data Filename window opens:



14. Enter the data file name (10 characters maximum) in the Enter the filename to store the CTD data text box, and then click OK.

The Continuous window opens indicating that the CTD is running in Continuous mode:

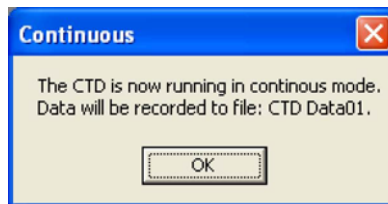

15. Click OK.

The Continuous window and the CTD-N Configuration dialog box close. Data will continue to be acquired and stored until data logging is stopped, the memory is full or the battery pack is depleted.

16. Disconnect the test cable from the instrument and install the dummy plug.

	CAUTION. Failure to install the dummy plug will cause the connector pins to corrode and may cause damage to the instrument.
--	--

17. Deploy the instrument in the required manner.

Configuring and Deploying the CTD-N in Interval Mode

To configure a CTD-N for deployment and to acquire and store data in Interval mode:

1. If necessary, replace the battery pack in the CTD-N. (See [Cleaning the CTD-N](#) and [Replacing the Battery Pack](#) for instructions on how to replace the battery pack.)

	NOTE. Replacing the battery pack will not affect the instrument's configuration, stored data, or time and date settings.
--	---

2. Connect the CTD-N to your computer.
3. Choose Start > All Programs > RD Instruments > CTDPro.

CTDPro starts and the CTDPro Main window opens.

4. Choose CTD > Configure and Deploy.

If the CTD-N is currently logging data, a window opens asking if you want to stop logging:

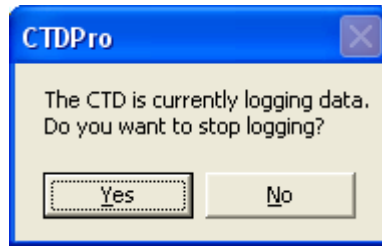

5. Click Yes to stop data logging, or click No to continue.

If you click No, the window closes and data acquisition continues without interruption.

If you click yes, data logging stops, the window closes and the CTD-N Configuration dialog box shown in Figure 13 opens.

6. If the local time and date require setting, click Set Time Date in the CTD-N-CTD Configuration dialog box.

The Set Time window opens displaying the time and date as acquired from the computer on which CTDPro is running, along with the difference in time between that of the computer and the instrument.

Click OK to save the new time and date and close the Set Time window.

7. In the Running Mode area of the CTD-N Configuration dialog box, select Interval.
8. Using the up and down arrows in the Interval Time and Record Time scroll boxes, enter the Interval Time and Record Time in hours, minutes and seconds (hh:mm:ss). Or instead, click inside each of the scroll boxes, one at a time, to open a Time window:



Enter the time in hours, minutes and seconds (hh:mm:ss) in the Enter the Time text box, and then click OK. The minimum Record Time is 10 seconds.

9. In the Sampling Rate area, select the desired sampling rate in hertz of the CTD-N from the drop-down list box.
10. In the Average Time area, use the up and down arrows in the Length scroll box to enter the Average Time in minutes and seconds (mm:ss).
11. Click Deploy.

The Erase Memory window opens:

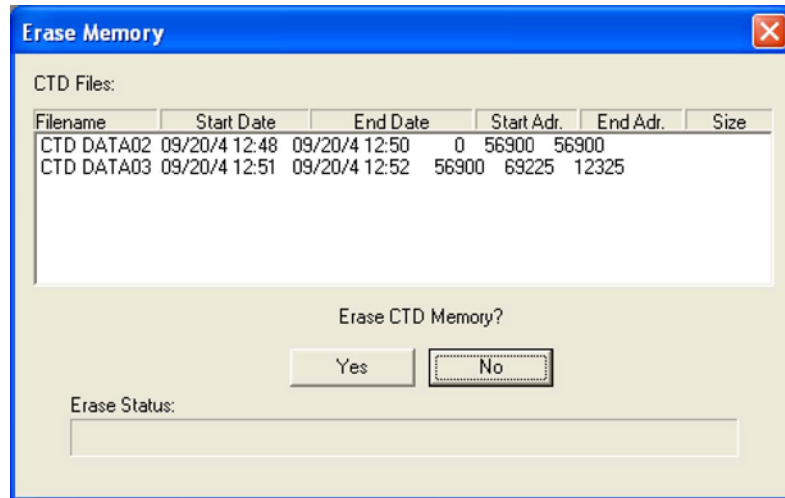

 **NOTE.** Clicking No in the Erase Memory window will append the new data file to the last data file stored in memory. No memory will be erased.

12. To erase all of memory, click Erase.

A CTDPro window opens asking if you want to erase all of memory:

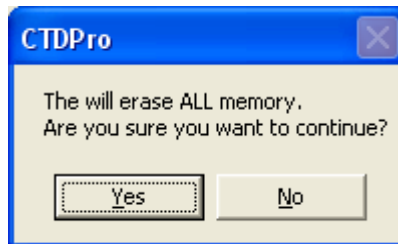

13. Click Yes to confirm that you want to erase all of memory.

The memory is erased as indicated by the Erase Status progress bar in the Erase Memory window, and then the Data Filename window opens:

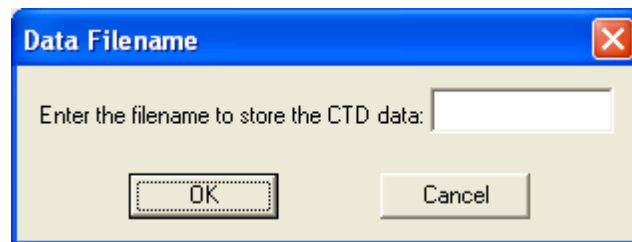

14. Enter the data file name (10 characters maximum) in the Enter the filename to store the CTD data text box, and then click OK.

The Interval window opens indicating that the CTD is running in Interval mode:

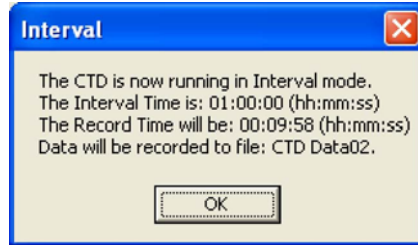

15. Click OK.

The Interval window and the CTD-N Configuration dialog box close. Data will continue to be acquired and stored until data logging is stopped, the memory is full or the battery pack is depleted.

16. Disconnect the test cable from the instrument and install the dummy plug.



CAUTION. Failure to install the dummy plug will cause the connector pins to corrode and may cause damage to the instrument.

17. Deploy the instrument in the required manner.

Configuring and Deploying the CTD-N in Delayed Start Continuous Mode

To configure a CTD-N for deployment and to acquire and store data in Delayed Start Continuous mode:

1. If necessary, replace the battery pack in the CTD-N. (See [Cleaning the CTD-N](#) and [Replacing the Battery Pack](#) for instructions on how to replace the battery pack.)



NOTE. Replacing the battery pack will not affect the instrument's configuration, stored data, or time and date settings.

2. Connect the CTD-N to your computer.
3. Choose Start > All Programs > RD Instruments > CTDPro.

CTDPro starts and the CTDPro Main window opens.

4. Choose CTD > Configure and Deploy.

If the CTD-N is currently logging data, a window opens asking if you want to stop logging:

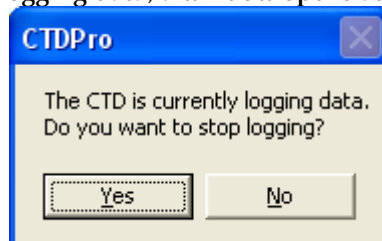

- Click Yes to stop data logging, or click No to continue.

If you click No, the window closes and data acquisition continues without interruption.

If you click yes, data logging stops, the window closes and the CTD-N Configuration dialog box shown in Figure 13 opens.

- If the local time and date require setting, click Set Time Date in the CTD-N-CTD Configuration dialog box.

The Set Time window opens displaying the time and date as acquired from the computer on which CTDPro is running, along with the difference in time between that of the computer and the instrument.

Click OK to save the new time and date and close the Set Time window.

- In the Running Mode area of the CTD-N Configuration dialog box, select Delayed Start Continuous.
- Enter the Start Date in months, days, and years (mm/dd/yyyy) in the Start Date scroll box by clicking the month, day and year digits, one at a time, and then entering the information directly. Or instead, click the down arrow to open a calendar:



Click the left or right arrow to select the month and year, and then click the day.

- Enter the Start Time in hours, minutes and seconds (hh:mm:ss) in the Start Time scroll box by clicking the hours, minutes and seconds digits, one at a time, and then clicking the up and down arrows or entering the information directly. Enter "a" or "A" for AM or "p" or "P" for PM or use the up and down arrows.
- In the CTD Sampling Rate area, select the desired sampling rate in hertz of the CTD-N from the drop-down list box.
- In the Average Time area, use the up and down arrows in the Length scroll box to enter the Average Time in minutes and seconds (mm:ss).
- Click Deploy.

The Erase Memory window opens: Click Yes to confirm that you want to erase all of memory.

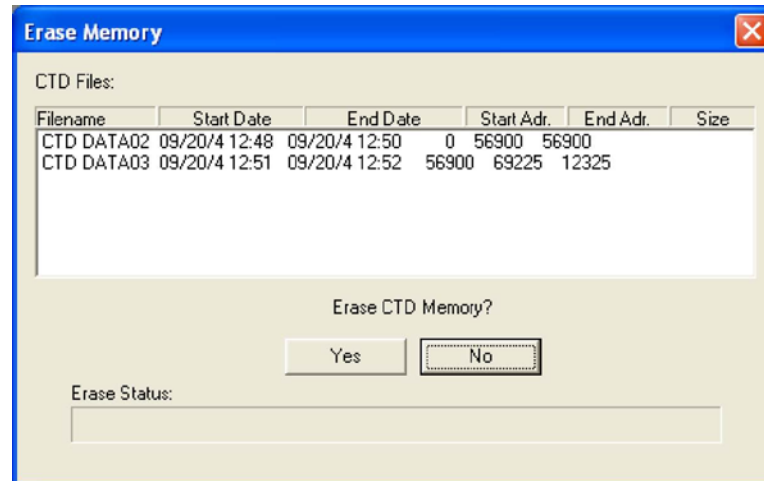

NOTE. Clicking No in the Erase Memory window will append the new data file to the last data file stored in memory. No memory will be erased.

13. To erase all of memory, click Erase.

A CTD-N window opens asking if you want to erase all of memory:

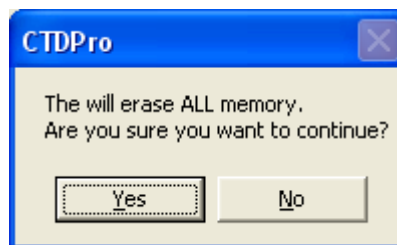

14. Click Yes to confirm that you want to erase all of memory

The memory is erased as indicated by the Erase Status progress bar in the Erase Memory window, and then the Data Filename window opens:

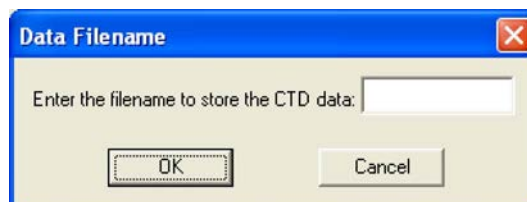

15. Enter the data file name (10 characters maximum) in the Enter the filename to store the CTD data text box, and then click OK.

The Delayed Start Continuous window opens indicating that the CTD is running in Delayed Start Continuous mode:



16. Click OK.

The Delayed Start Continuous window and the CTD-N Configuration dialog box close. Data will continue to be acquired and stored until data logging is stopped, the memory is full, or the battery pack is depleted.

17. Disconnect the test cable from the instrument and install the dummy plug.

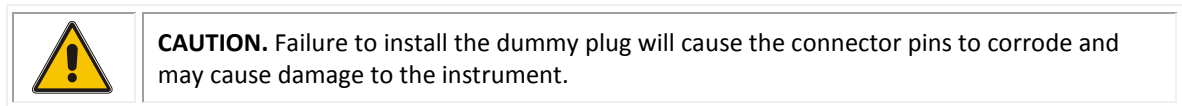

18. Deploy the instrument in the required manner.

Configuring and Deploying the CTD-N in Delayed Start Interval Mode

To configure a CTD-N for deployment and to acquire and store data in Delayed Start Interval mode:

1. If necessary, replace the battery pack in the CTD-N. (See [Cleaning the CTD-N](#) and [Replacing the Battery Pack](#) for instructions on how to replace the battery pack.)

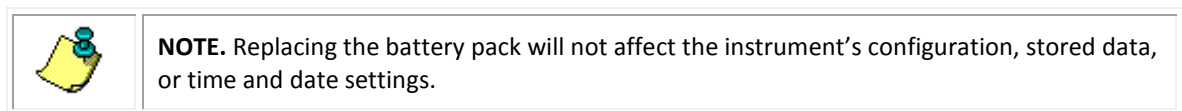

2. Connect the CTD-N to your computer.
3. Choose Start > All Programs > RD Instruments > CTDPro.

CTDPro starts and the CTDPro Main window opens.

4. Choose CTD > Configure and Deploy.

If the CTD-N is currently logging data, a window opens asking if you want to stop logging:

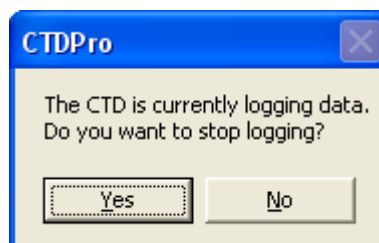

5. Click Yes to stop data logging, or click No to continue.

If you click No, the window closes and data acquisition continues without interruption.

If you click yes, data logging stops, the window closes and the CTD-N Configuration dialog box shown in Figure 13 opens.

6. If the local time and date require setting, click Set Time Date in the CTD-N-CTD Configuration dialog box.

The Set Time window opens displaying the time and date as acquired from the computer on which CTDPro is running, along with the difference in time between that of the computer and the instrument.

Click OK to save the new time and date and close the Set Time window.

7. In the Running Mode area of the CTD-N Configuration dialog box, select Delayed Start Interval.
8. Enter the Start Date in months, days, and years (mm/dd/yyyy) in the Start Date scroll box by clicking the month, day and year digits, one at a time, and then entering the information directly. Or instead, click the down arrow to open a calendar:



Click the left or right arrow to select the month and year, and then click the day.

9. Enter the Start Time in hours, minutes and seconds (hh:mm:ss) in the Start Time scroll box by clicking the hours, minutes and seconds digits, one at a time, and then clicking the up and down arrows or entering the information directly. Enter "a" or "A" for AM or "p" or "P" for PM or use the up and down arrows.
10. Using the up and down arrows in the Interval Time and Record Time scroll boxes, enter the Interval Time and Record Time in hours, minutes and seconds (hh:mm:ss). Or instead, click inside each of the scroll boxes, one at a time, to open a Time window:

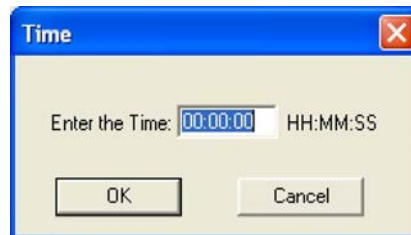



Enter the time in hours, minutes and seconds (hh:mm:ss) in the Enter the Time text box, and then click OK. The minimum Record Time is 10 seconds.

11. In the CTD Sampling Rate area, select the desired sampling rate in hertz of the CTD-N from the drop-down list box.

12. In the Average Time area, use the up and down arrows in the Length scroll box to enter the Average Time in minutes and seconds (mm:ss).
13. Click Deploy.

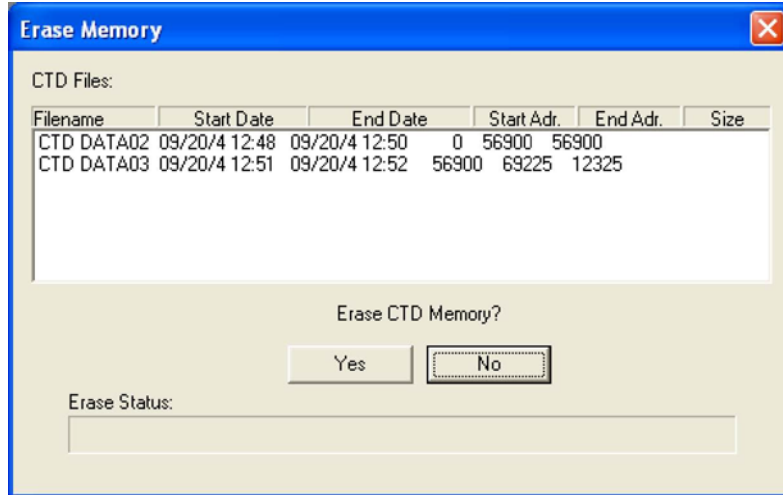
The Erase Memory window opens:



 **NOTE.** Clicking No in the Erase Memory window will append the new data file to the last data file stored in memory. No memory will be erased.

14. To erase all of memory, click Erase.

A CTDPro window opens asking if you want to erase all of memory:

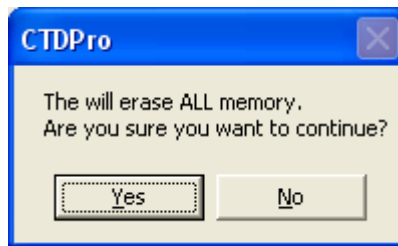

15. Click Yes to confirm that you want to erase all of memory.

The memory is erased as indicated by the Erase Status progress bar in the Erase Memory window, and then the Data Filename window opens:

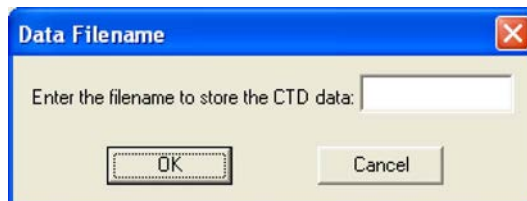

16. Enter the data file name (10 characters maximum) in the Enter the filename to store the CTD data text box, and then click OK.

The Delayed Start Interval window opens indicating that the CTD is running in Delayed Start Interval mode:

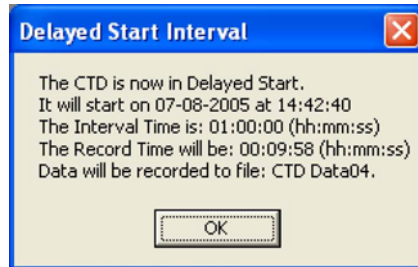

17. Click OK.

The Delayed Start Interval window and the CTD-N Configuration dialog box close. Data will continue to be acquired and stored until data logging is stopped, the memory is full or the battery pack is depleted.

18. Disconnect the test cable from the instrument and install the dummy plug.

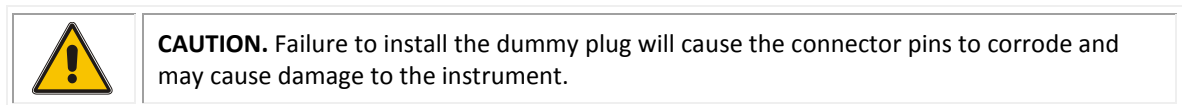

19. Deploy the instrument in the required manner.

Using Battery End Cap Enabled Interval Mode

When the Autolog is not being used, it is important to enable the battery switched mode. To enable this function choose View > Terminal to open a terminal window. Then type `***O<CR>` to get into Open mode and `BATSW=ON<CR>`. Now the CTD-N will run in Interval operating mode whenever power is applied. Connecting the battery-shortening plug will cause the CTD-N to open a file and start taking interval data immediately. The files will be automatically sequentially named starting with INT01. Once the deployment is completed the battery switch plug needs to be removed and the adaptor cable connected. Another interval will automatically start and a new file created. This file will not have data from the deployment and can be ignored.

Battery End Cap Enabled – Delayed Start Interval

It is possible to use Delay Start Mode with the battery switched end cap. In CTDPro, only use Delay Start Interval in the Running Mode area. Setup the delay time and date normally and deploy. When the Data Filename dialog box opens you need to enter a filename. Note that this file will be deleted when the adapter cable is disconnected and the unit loses power. When the battery-shortening plug is connected and power is restored, a file will be created (INT01 if this is the first file in memory) and one interval will be run before the unit goes into low power mode. When the delay time arrives the unit will start taking data intervals and append that data to the file started when the battery was powered. Once the deployment is completed the battery switch plug needs to be removed and the adaptor cable connected. Another interval will automatically start and a new file created. This file will not have data from the deployment and can be ignored.

CTD-N Autolog Feature

The CTD-N Autolog feature instructs the instrument to create a new file and start logging upon submersion in salt water. This is extremely advantageous to users as it permits logging to a new file without having to reconnect a computer to the instrument to manually instruct the instrument to start logging. Users can also save valuable battery energy when this feature is used in conjunction with TRDI's optional battery end cap switch.

More specifically, the Autolog feature will open a new file and begin logging when the conductivity rises above a threshold of 1mS/cm for more than 30 seconds. Logging will stop and the file will close approximately 30 seconds from the time that the conductivity drops below the 1mS/cm threshold. Figure 23 illustrates this behavior of the Autolog feature, which is only valid when the operating mode of the instrument is set to 'Run mode.' If the operating mode of the instrument is not set to 'Run Mode,' the Autolog feature will not work. This behavior can be viewed in the terminal window, which can be opened by following the menu path view>terminal. When the instrument senses that it is in water above the conductivity threshold for 30 seconds, the instrument streams out "Opening file: DataXX" where XX is the file number. Then when the instrument senses that it is out of the water (i.e., the conductivity is below the threshold) for 30 seconds, the instrument streams out "Closing file: DataXX" where XX is again the file number. Files are named as DATA01, DATA02 and so forth when the Autolog feature is used.



NOTE. There is known bug with this feature where the first file generally comes up empty. A work-around implemented by some users is to dunk the CTD in a bucket of salt water before the first cast. This bug will be fixed in the next iteration of CTDPro.

Data can only be logged continuously when using the Autolog feature. Data can not be logged periodically, as is an option when manually instructing the instrument to log to a file using the Configure and Deploy dialog box in CTDPro. The Configure and Deploy dialog box should not be used if the Autolog feature is desired. If the instrument is manually instructed to log to a file using the Configure and Deploy dialog box, then it will do so whether or not the Autolog feature is turned on or off.

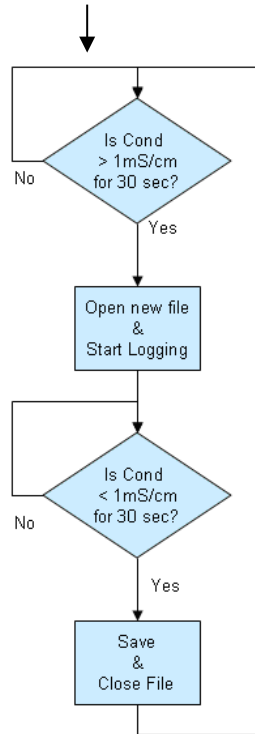

Figure 23. Flowchart for the CTD-N Autolog Feature



NOTE. This chart assumes the instrument is in the 'Run' operating mode.



CAUTION. The file will be lost if power is removed before the file is closed! To ensure that the data file has been saved and closed properly, wait more than thirty seconds after removing the CTD-N from the water before disconnecting power to the CTD-N. It is advisable to wait a couple of minutes to ensure that the file closes. Similarly, wait more than 30 seconds before redeployment, or else a new file will not be created, and logging will continue on the same file.

The instrument is capable of storing 17 separate files. Thus 17 such submersion events are possible while maintaining all data. The 18th file is overwritten every subsequent time the instrument is submergued.

Selecting and Activating the Autolog Feature

To activate the Autolog feature in CTDPro go to the Advanced Setting dialog box with the menu path **CTD > Communications > Advanced Settings**. Then, check the box that reads **Autolog on Power Up, Low Conductivity will stop logging**, and click **OK** to save this change.

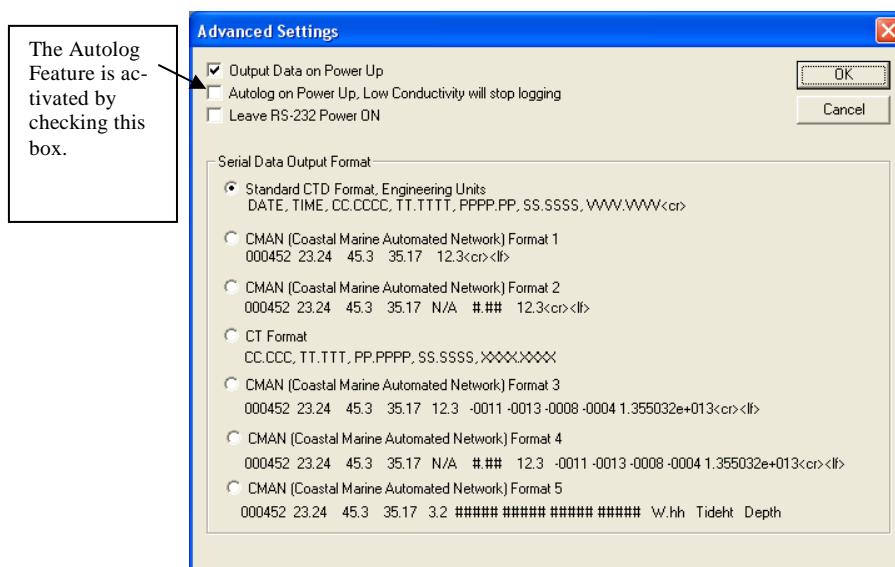

Figure 24. Activating the Autolog feature in the Advanced Settings dialog box

Alternatively, the user can use the terminal window to set the CTD-N to Autolog by using the AUTO command. AUTO=ON turns on the Autolog feature, while AUTO=OFF turns off the Autolog feature. Store the settings to EEPROM by using the save command, "***E".



CAUTION. Any change to the instrument's setting, such as changing the AUTO parameter from OFF to ON, must be saved or else the change will not be effected when the instrument is powered OFF.

Once the Autolog feature has been turned on by either method described above, the instrument must be placed into 'Run mode' to activate the Autolog feature. The two methods of going to 'Run mode' are to enter "***R" in the terminal program or to cycle the power to the instrument (on power up, the instrument enters Run Mode). Cycling the power is sometimes not an option, in which case, the former method is required.

Autolog Typical Applications and Procedures

Several applications are discussed here, with the steps necessary to properly use the Autolog feature.

Using the Autolog feature with battery power in conjunction with the battery end-cap switch

The user can save valuable battery energy by using the Autolog feature in conjunction with TRDI's battery end cap switch option for the CTD-N series. This switch breaks and makes the connection from the battery to instrument electronics. Thus, the user can set up the instrument to Autolog and then break the battery connection to the instrument to save energy. The instrument is ready at any time to deploy without any further need to connect the instrument to a personal computer. The user can simply make the battery connection to the instrument and deploy the instrument. Here are the explicit steps for setting up the Autolog feature with battery power in conjunction with the battery end cap switch.

1. Install the battery inside the instrument housing
2. Connect the communications cable from the computer to the instrument. External power can be connected to save battery power.

3. Open CTDPro.
4. Select the Autolog feature from the Advanced Settings dialog box.
5. Close the dialog box.
6. Choose the 'Sample Rate' and the 'Average Time' in the Settings dialog box.
7. Close the dialog box.
8. Close CTDPro.
9. Disconnect the communications cable from the instrument.
10. Leave the communications port of the instrument empty or, to ensure a clean port, plug it with a dummy plug (i.e., a plug that breaks the battery connection to the instrument).
11. Wait until it is time to deploy the instrument. This can be days, months, or years.
12. Plug the communications port of the instrument with a plug that makes the connection between the battery and the instrument (i.e. shorting plug). The instrument boots up into run mode, thus Autolog feature is activated.
13. Deploy the instrument.
14. After 30 seconds in water of 1mS/cm or greater, the instrument will start to log to a new file.
15. Wait to recover the instrument.
16. Recover the instrument (i.e., pull it out of the water).
17. After 30 seconds out of the water, the instrument will automatically stop logging to the file, save the file and close the file. Confirm that water has flushed out of the conductivity cell, otherwise, the instrument may still be logging. **The file will be lost if power is removed before the file is closed!** To ensure that the data file has been saved and closed properly, wait more than thirty seconds after removing the NXIC CTD from the water before disconnecting the shorting plug (i.e., disconnecting power to the instrument). In fact, it is advisable to wait a couple of minutes to ensure that the file closes. Similarly, wait more than 30 seconds before redeployment, or else a new file will not be created, and logging will continue on the same file.
18. Disconnect the shorting plug.
19. If the user wants to download the data, then go to step 22.
20. Plug the communications port with a dummy plug (i.e., a plug that breaks the battery connection to the instrument) until the next deployment is desired.
21. Go back to step 11.
22. Connect the communications cable from the computer to the instrument. External power can be connected to save battery power.
23. Open CTDPro.

24. Download CTD data file by following the path CTD>Memory>View Files.
25. View the data graphically in CTDPro or export to a txt for use with other analysis software.

Using the Autolog Feature with Battery Power, But Without the Battery End Cap Switch

The steps for using the Autolog feature on a battery powered instrument without the end cap switch as opposed to one with the end cap switch are a little different. First, without a way to externally break and make the connection from the battery to the instrument, the instrument will be depleting the battery from the time it is setup to the time it is deployed. If this time is short, then the end cap switch isn't greatly missed. Secondly, the user must ensure that the instrument is commanded into run mode using CTDPro's terminal window, as cycling the power is not an option with the battery enclosed in the instrument. To command the instrument to run mode type "***R" in the terminal window and hit the 'Enter' key. The user can avoid wasting battery energy and avoid having to command the instrument to run mode by installing the battery after the instrument's Autolog feature is enabled (as well as saved) and before the instrument is to be deployed.

Using the Autolog Feature with Permanent External Power

If the instrument is externally powered and the power can not be cycled for any reason, then the user must ensure that the instrument is commanded into run mode in order to activate the Autolog feature. To command the instrument to run mode, type "***R" in the terminal window and hit the 'Enter' key.

Retrieving and Displaying Data from the CTD-N

Data that are stored in the CTD-N can be downloaded file by file to your computer. Once downloaded, the data can be exported to a text or spreadsheet file for viewing and printing, or to CTDPost for post processing. The data can also be viewed on graphs and the graphs printed and saved. This section provides instructions on how to download and save data that are stored in the CTD-N, and once saved, how to export the data for viewing, printing and processing. Instructions are also provided on how to erase all the data in the instrument.



NOTE. The CTD-N always records measured conductivity, temperature, and pressure, along with calculated salinity and sound velocity, the date and time, the battery voltage, and the optional external sensor data. In addition, when exporting data to a text or spreadsheet file, or to CTDPost, you can choose to have CTDPro calculate additional parameters from the measured parameters as described in [Exporting Saved Data](#). The measured parameters, the parameters calculated by the CTD-N and the parameters calculated by CTDPro are listed and described in [APPENDIX A: Measured and Calculated Parameters](#).

Downloading and Saving Data from the CTD-N

Data that are stored in the CTD-N can be downloaded file by file to your computer and saved as CTD files, files with extension *.ctd*. Once downloaded, the data can be exported to a text or spreadsheet file for viewing and printing, or to CTDPost for post processing.

To download data from a CTD-N:

1. Connect the CTD-N to your computer.
2. Choose Start > All Programs > RD Instruments > CTDPro.

CTDPro starts and the CTDPro Main window opens.

3. Choose CTD > Memory > View Files.

If the CTD-N is currently logging data, a window opens asking if you want to stop logging:

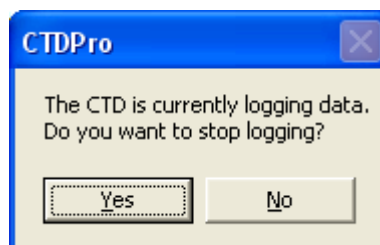

4. Click Yes to stop data logging, or click No to continue.

If you click No, the window closes and data acquisition continues without interruption.

If you click yes, data logging stops, the CTD-N window closes and the Download dialog box shown in Figure 25 opens.

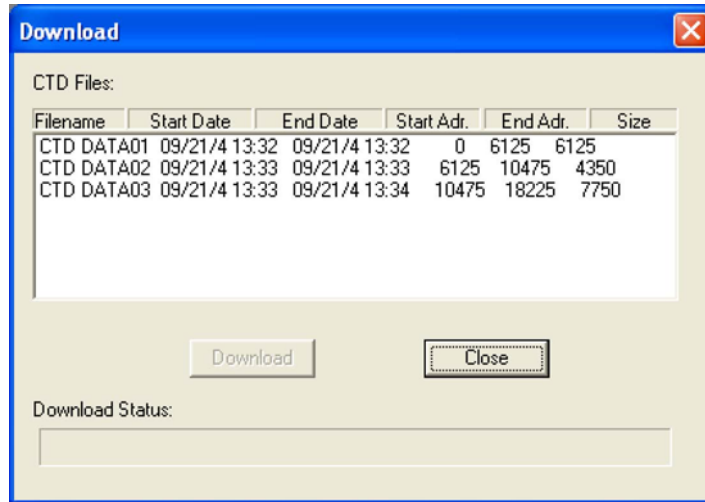

Figure 25. The Download Dialog Box

5. Click the file you want to download, and then click Download.

The Save As dialog box for CTD data files shown in Figure 26 opens. This dialog box is used to create the file in which to save the retrieved data.

6. Click the arrow in the Save in drop-down list box and select the folder in which to save the data file.

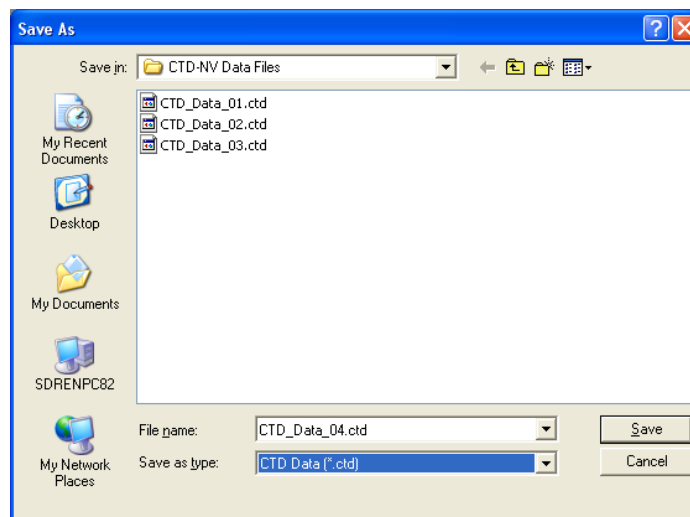

Figure 26. The Save As Dialog Box for CTD Data Files

- In the File name text box enter the name of the file in which to save the data. The extension *.ctd* is added automatically.



NOTE. Windows 7® will not save any data files to the folder selected in the dialog box. Instead it saves to the desktop by default. This is a known bug that will be addressed in a future release of CTDPro.

- Click Save.

The Save As dialog box for data files closes and the data are downloaded and saved. The download process is indicated by the Download Status bar in the Download dialog box, and after the download is complete, the Download Time and Download windows open:

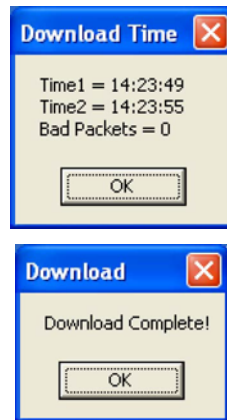

- Click OK in the Download Time and Download windows to close them.
- Select another file to download or click Close in the Download dialog box to close it.

Exporting and Viewing Saved Data

After data have been downloaded from the CTD-N and saved to a CTD data file, the data in the CTD file can be exported to a text file, a file of extension *.txt*, and viewed. The data can also be exported to a spreadsheet file or to CTDPost. The specific parameters to be exported can be selected, including calculated parameters and the date and time. You can view a text file directly in CTDPro or by using a text editor program installed on your computer. A spreadsheet program is required to view and process the data in a spreadsheet. When exporting to CTDPost, CTDPro creates three files: DAT, C00 and HDR. These files have extensions *.dat*, *.c00* and *.hdr*, respectively, and are used by CTDPost for processing.



NOTE. For the most accurate depth calculation, enter the latitude at which the CTD-N was deployed, if available, in the Latitude for Depth text box in the Properties dialog box. The Properties dialog box is shown in Figure 6. To open the Properties dialog box choose Properties from the File menu.

Exporting Saved Data

To export saved data as a text file, spreadsheet file or CTDPost file:

1. Choose Start ► All Programs ► RD Instruments ► CTDPro.

CTDPro starts and the CTDPro Main window opens.

2. Choose File ► Export.

The Export dialog box shown in Figure 27 opens:

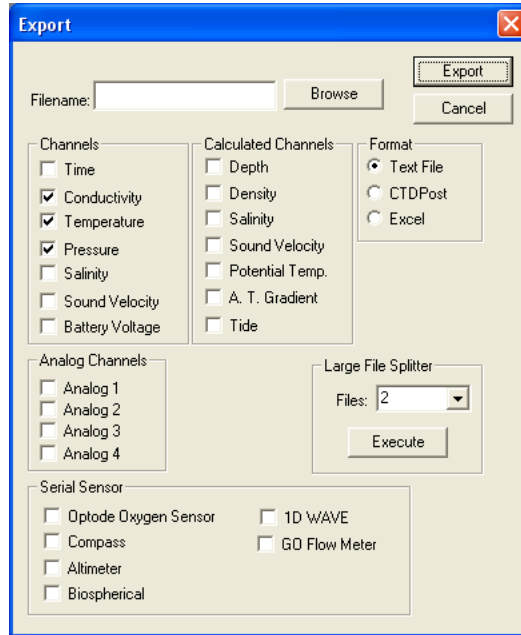

Figure 27. The Export Dialog Box

3. In the Channels, Calculated Channels and Analog Channels areas of the Export dialog box, select the corresponding check boxes for the data that you want to export. Clear the check boxes for the data that you do not.



NOTE. Parameters in the Channels area of the Export dialog box are measured or calculated by the CTD-N, parameters in the Calculated Channels area are calculated by CTDPro, and parameters in the Analog Channels area are the optional external sensor DC outputs.

4. In the Format area select the type of file to which to export.
5. Click Browse.

The Open dialog box for CTD data files shown in Figure 28 opens. If the file you want to export is not visible, it may be in a different folder than the one shown. In this case, click the arrow in the Look in drop-down list box and select the folder in which the file is located.

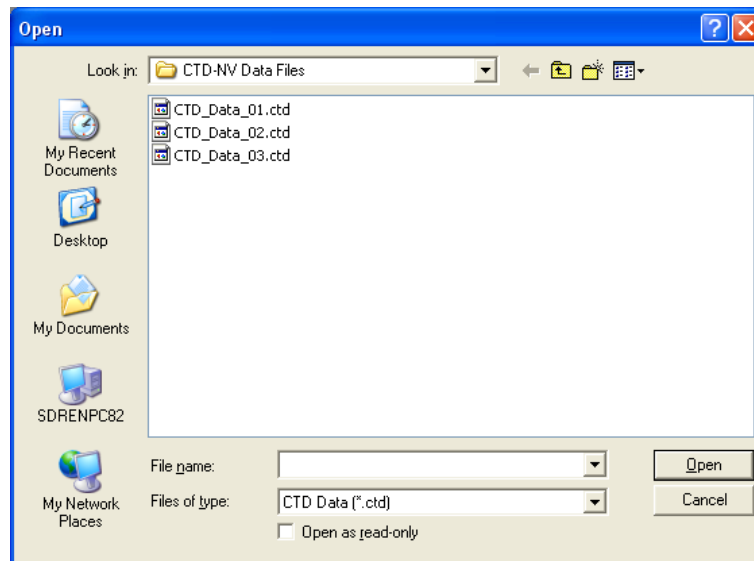

Figure 28. The Open Dialog Box for CTD Data Files

6. Click the CTD data file you want to export, and then click Open.

The Open dialog box for CTD data files closes and the file name is displayed in the Filename text box.

7. Click Export in the Export dialog box.

The data are exported to a file of the same file name and placed in the same directory as the original data file. The appropriate extension is also added to the file name, depending on whether it is a text file, spreadsheet file or a CTDPost file.

Viewing Data That Have Been Exported to a Text File

To view data that have been exported to a text file, choose File > View Text File, select the file from the Open dialog box for Text files, and then click Open. Or use Windows Explorer to navigate to the file and double-click it. Data are displayed in columns as shown in the example CTD-N data file printout in Figure 29.

CTD Data01.txt						
DATE	TIME	COND	TEMP	PRES	SALT	POT TEMP
mm-dd-yyyy	hh:mm:ss	(mmho/cm)	(C)	(dbar)	(PSU-78)	(C)
09-02-2004	22:54:35	0.0069	21.5036	0.0000	0.0121	21.5036
09-02-2004	22:54:35	0.0070	21.5044	0.0000	0.0122	21.5044
09-02-2004	22:54:35	0.0069	21.5050	0.0000	0.0121	21.5050
09-02-2004	22:54:35	0.0069	21.5058	0.0000	0.0121	21.5058
09-02-2004	22:54:35	0.0070	21.5065	0.0000	0.0121	21.5065
09-02-2004	22:54:36	0.0068	21.5069	0.0346	0.0121	21.5069
09-02-2004	22:54:36	0.0069	21.5074	0.0225	0.0121	21.5074
09-02-2004	22:54:36	0.0068	21.5080	0.0000	0.0121	21.5080
09-02-2004	22:54:36	0.0068	21.5080	0.0494	0.0121	21.5080
09-02-2004	22:54:36	0.0067	21.5082	0.0038	0.0120	21.5082
09-02-2004	22:54:37	0.0067	21.5081	0.0000	0.0120	21.5081
09-02-2004	22:54:37	0.0069	21.5085	0.0000	0.0121	21.5085
09-02-2004	22:54:37	0.0066	21.5082	0.0000	0.0120	21.5082
09-02-2004	22:54:37	0.0067	21.5070	0.0000	0.0120	21.5070
09-02-2004	22:54:37	0.0066	21.5058	0.0044	0.0120	21.5058
09-02-2004	22:54:38	0.0067	21.5041	0.0000	0.0120	21.5041
09-02-2004	22:54:38	0.0066	21.5029	0.0000	0.0120	21.5029
09-02-2004	22:54:38	0.0067	21.5017	0.0000	0.0120	21.5017
09-02-2004	22:54:38	0.0068	21.5005	0.0000	0.0121	21.5005
09-02-2004	22:54:38	0.0069	21.4989	0.0000	0.0121	21.4989
09-02-2004	22:54:39	0.0067	21.4969	0.0181	0.0120	21.4969
09-02-2004	22:54:39	0.0069	21.4944	0.0000	0.0121	21.4944
09-02-2004	22:54:39	0.0065	21.4919	0.0253	0.0120	21.4919
09-02-2004	22:54:39	0.0065	21.4900	0.0599	0.0120	21.4899
09-02-2004	22:54:39	0.0065	21.4874	0.0144	0.0120	21.4874
09-02-2004	22:54:40	0.0064	21.4849	0.0082	0.0119	21.4849
09-02-2004	22:54:40	0.0069	21.4828	0.0544	0.0121	21.4828
09-02-2004	22:54:40	0.0070	21.4804	0.0500	0.0121	21.4804
09-02-2004	22:54:40	0.0070	21.4788	0.0000	0.0121	21.4788
09-02-2004	22:54:40	0.0070	21.4774	0.0211	0.0121	21.4774
09-02-2004	22:54:41	0.0070	21.4761	0.0060	0.0121	21.4761
09-02-2004	22:54:41	0.0068	21.4748	0.0471	0.0121	21.4748
09-02-2004	22:54:41	0.0069	21.4721	0.0078	0.0121	21.4721
09-02-2004	22:54:41	0.0070	21.4712	0.0152	0.0121	21.4712
09-02-2004	22:54:41	0.0068	21.4690	0.0000	0.0121	21.4690
09-02-2004	22:54:42	0.0069	21.4663	0.0000	0.0121	21.4663
09-02-2004	22:54:42	0.0069	21.4633	0.0000	0.0121	21.4633
09-02-2004	22:54:42	0.0071	21.4609	0.0000	0.0122	21.4609
09-02-2004	22:54:42	0.0069	21.4579	0.0000	0.0121	21.4579
09-02-2004	22:54:42	0.0067	21.4554	0.0000	0.0120	21.4554
09-02-2004	22:54:43	0.0069	21.4539	0.0002	0.0121	21.4539
09-02-2004	22:54:43	0.0068	21.4527	0.0000	0.0121	21.4527
09-02-2004	22:54:43	0.0069	21.4518	0.0039	0.0121	21.4518
09-02-2004	22:54:43	0.0070	21.4516	0.0000	0.0122	21.4516
09-02-2004	22:54:43	0.0069	21.4517	0.0210	0.0121	21.4517
09-02-2004	22:54:44	0.0070	21.4523	0.0257	0.0121	21.4523
09-02-2004	22:54:44	0.0070	21.4523	0.0273	0.0121	21.4523
09-02-2004	22:54:44	0.0070	21.4532	0.0000	0.0121	21.4532
09-02-2004	22:54:44	0.0071	21.4541	0.0000	0.0122	21.4541
09-02-2004	22:54:44	0.0068	21.4550	0.0000	0.0121	21.4550
09-02-2004	22:54:45	0.0065	21.4560	0.0000	0.0120	21.4560
09-02-2004	22:54:45	0.0065	21.4569	0.0000	0.0120	21.4569
09-02-2004	22:54:45	0.0067	21.4579	0.0166	0.0120	21.4579
09-02-2004	22:54:45	0.0068	21.4583	0.0803	0.0121	21.4583
09-02-2004	22:54:45	0.0067	21.4584	0.0000	0.0120	21.4584
09-02-2004	22:54:46	0.0068	21.4588	0.0000	0.0121	21.4588
09-02-2004	22:54:46	0.0068	21.4587	0.0000	0.0121	21.4587
09-02-2004	22:54:46	0.0068	21.4586	0.0000	0.0121	21.4586
09-02-2004	22:54:46	0.0068	21.4584	0.0000	0.0121	21.4584
09-02-2004	22:54:46	0.0067	21.4576	0.0000	0.0120	21.4576
09-02-2004	22:54:47	0.0068	21.4575	0.0180	0.0121	21.4575

Page 1

Figure 29. Example CTD-N Data File Printout

Displaying, Printing, and Saving Graphs

After the data have been downloaded from the CTD-N and saved to a CTD data file, the data in the CTD file can viewed on graphs in a graphics display, and the graphs can be printed and saved. CTDPro provides graphs of the parameters that are measured and calculated by the CTD-N and the parameters that are calculated by CTDPro.

The parameters measured or calculated by the CTD-N are the following:

- Conductivity
- Temperature

- Pressure
- Salinity
- Sound Speed
- Battery Voltage

The parameters calculated by CTDPro are the following:

- Conductivity and Temperature versus Pressure
- Salinity
- Sound Velocity
- Density
- TS Plot

Displaying Data versus Pressure or Time

You can display data either versus pressure or versus time on the horizontal axis of a graph. This selection is made in the Properties dialog box, which is shown in Figure 6. To open the Properties dialog box, choose File > Properties. To select time for the horizontal axis, select the vs. Time option in the Plot Type area of the Properties dialog; to select pressure select the vs. Pressure option.

Viewing Data on a Graph

To view data on a graph:

1. Choose Start > All Programs > RD Instruments > CTDPro.

CTDPro starts and the CTDPro Main window opens.

2. Choose File > Open.

The Open dialog box for CTD data files shown in Figure 28 opens. If the file you want to open is not visible, it may be in a different folder than the one shown. In this case, click the arrow in the Look in drop-down list box and select the folder in which the file is located.

3. Click the CTD data file for which you want to display graphs, and then click Open.

The Open dialog box for CTD data files closes and the graphics display shown in Figure 30 opens to the Conductivity graph.

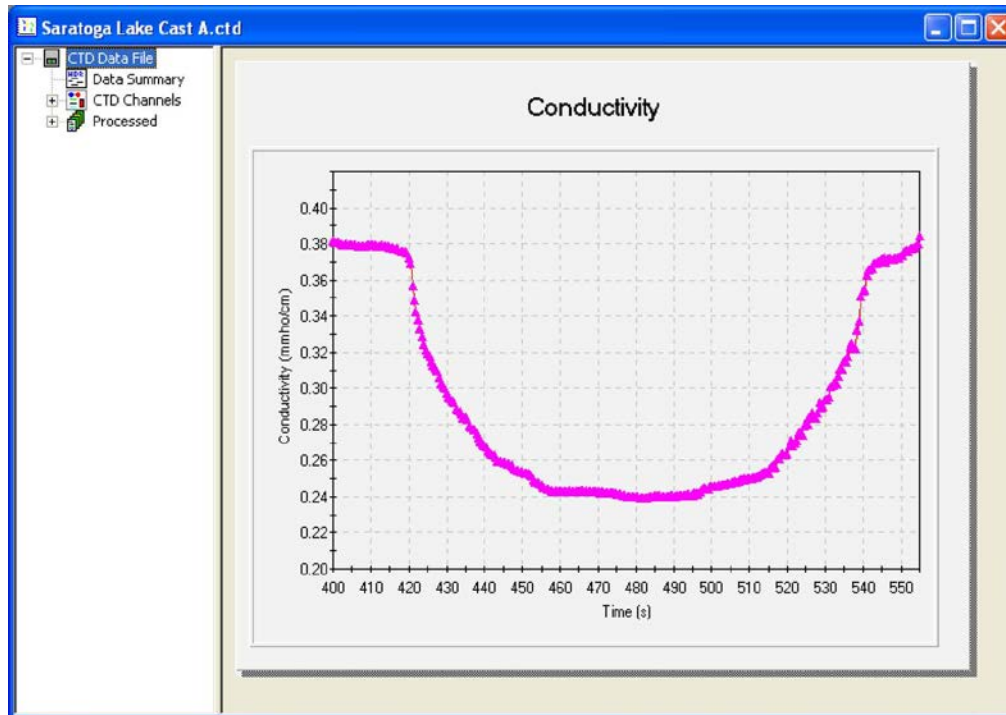

Figure 30. The Graphics Display Opened to the Conductivity Graph

4. To display a list of available CTD Channels data parameters, click the plus sign (+) to the left of CTD Channels.

To display a list of available Processed data parameters, click the plus sign (+) next to Processed.

5. To display a graph of any parameter in the CTD Channels data parameters list or the Processed data parameters list, click the parameter in the list.



NOTE. The Conductivity graph is always displayed initially by default.

The selected graph is displayed in the graphics display as shown Figure 32 for the temperature data and in Figure 33 for the pressure data.

Zooming in and Out of a Graph

To zoom in on a graph, press and hold the Shift key and click and hold the left mouse button while drawing a box around the area you want to zoom in on, and then release the mouse button.

To zoom out to the full view of the graph, type "R."

Setting up a Graph

The graph in the graphics display can be set up, allowing you to select the scaling, the labeling, the colors, the style, and a number of other settings. To set up a graph, view the graph as described in [Viewing Data on a Graph](#), and then right click anywhere in the graph. The 2D Chart Control Properties dialog box shown in Figure 31 opens. All the graph settings are made in the 2D Chart Control

Properties dialog box. For complete instructions on how to set up the graph, click Help in the dialog box.

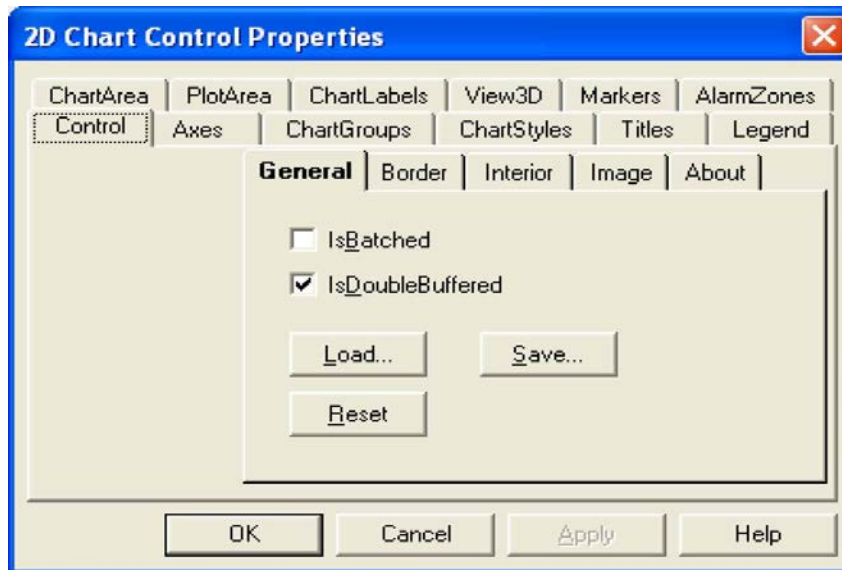

Figure 31. The 2D Chart Control Properties Dialog Box

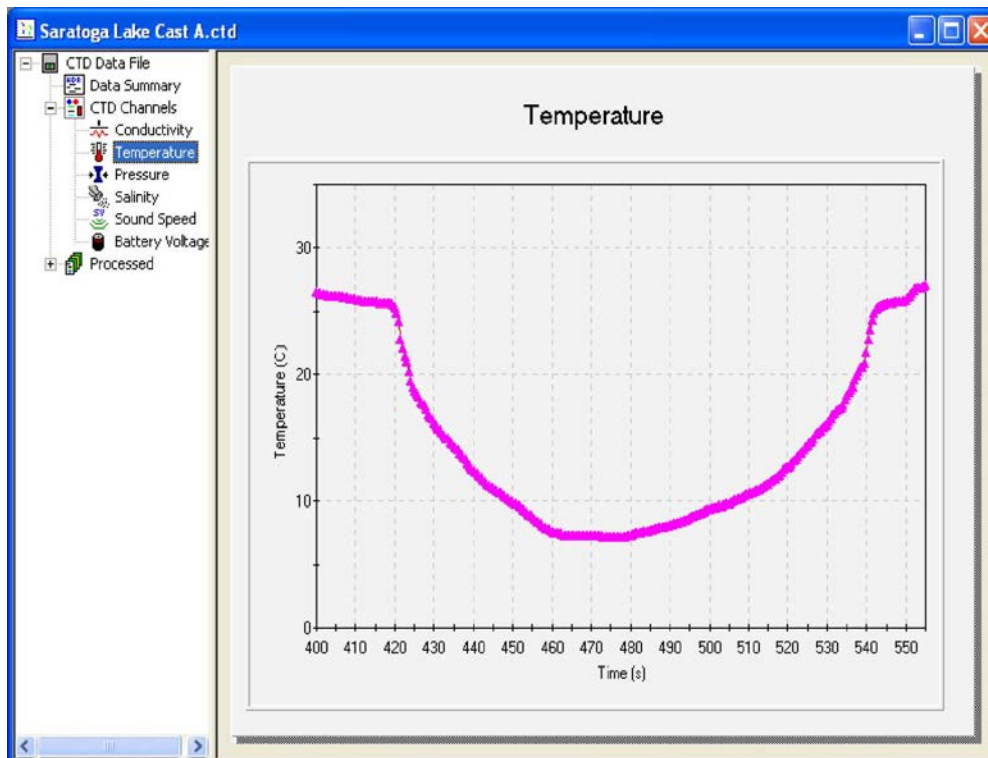

Figure 32. The Temperature Graph

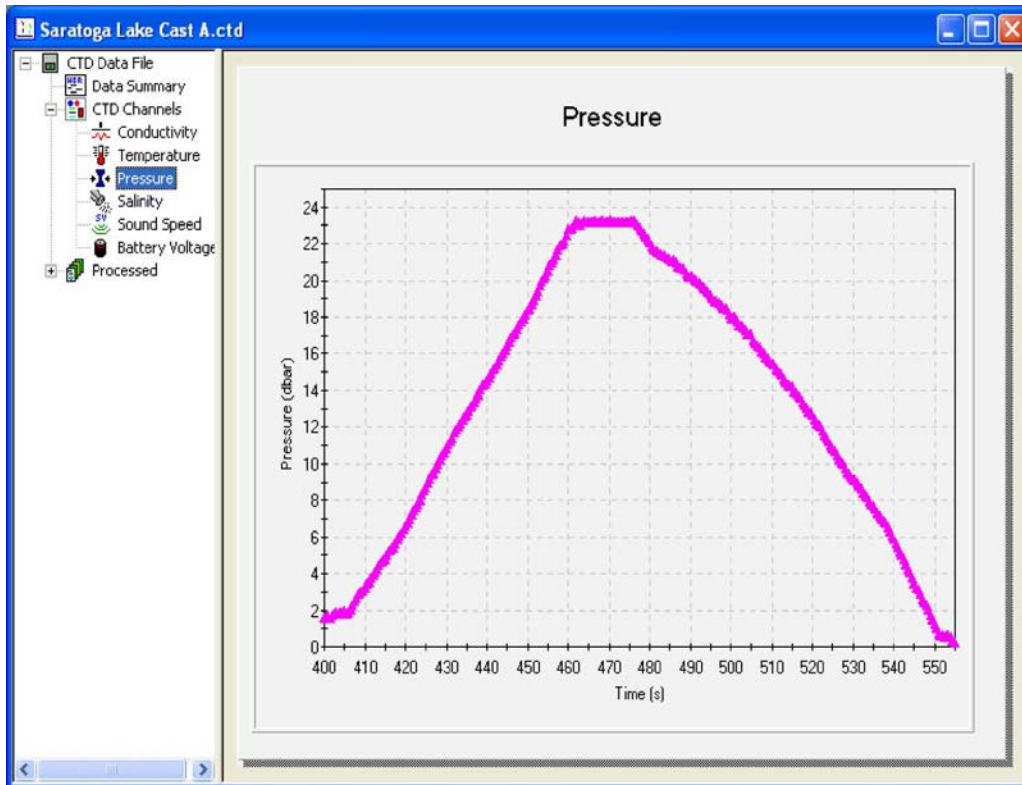

Figure 33. The Pressure Graph

Saving a Graph

Graphs can be saved as JPG files, files of extension *.jpg*, and opened in any photo editor.

To save a graph:

1. View the graph as described in [Viewing Data on a Graph](#).
2. Choose File ➤ Save Graph.

The Save Graph dialog box shown in Figure 34 opens.

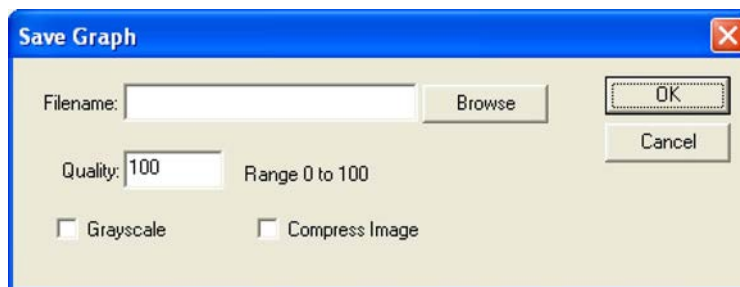

Figure 34. Save Graph Dialog Box

3. Click Browse

The Save As dialog box for image files shown in Figure 35 opens. This dialog box is used to create the file in which to save the image file.

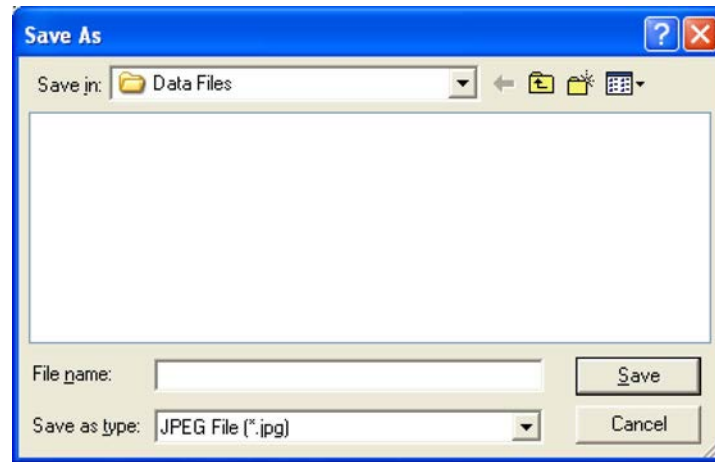

Figure 35. The Save As Dialog Box for Image Files

4. Click the arrow in the Save in drop-down list box and select the folder in which to save the image file.
5. In the File name text box enter the name of the file in which to save the data. The extension *.jpg* is added automatically.
6. Click Save.

The Save As dialog box for image files closes.

7. Enter the quality of the image—as an integer from 0 to 100—in the Quality text box in the Save Graph dialog box. The higher the number the higher the quality and the larger the file size.
8. If a grayscale image is desired, select the Grayscale check box.
9. To compress the image and reduce the file size, select the Compress Image check box.
10. Click OK.

The graph is saved and can be opened in any image editor.

Previewing and Printing a Graph

To print a graph without previewing, view the graph as described in [Viewing Data on a Graph](#), choose File > Print, and then follow the printing instructions for your printer. To set up the printer or select a different one, choose File > Print Setup.

To preview the printed graph, choose File > Print Preview.

Viewing File Information

To view file information about the data file, view the graph as described in [Viewing Data on a Graph](#), and then click Data Summary. The File Information window shown in Figure 36 opens. The

File Information window displays information particular to the opened file, including serial number, the calibrations date, the sample rate, the running mode, the run times, and the total number of recorded scans. To close the File Information window, click OK.

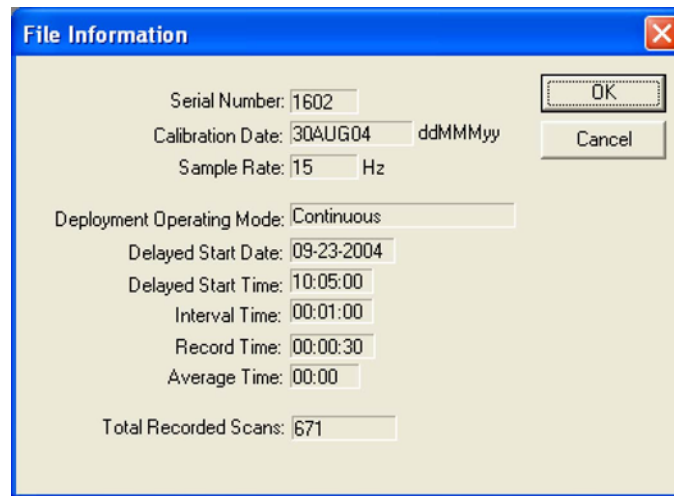

Figure 36. The File Information Window

Erasing All the Data Files

All the data files that stored in the CTD-N can be erased if the instrument is not logging data.

To erase all the data files in the CTD-N:

1. Connect the CTD-N to your computer.
2. Choose Start > All Programs > RD Instruments > CTDPro.

CTDPro starts and the CTDPro Main window opens.

3. Choose CTD > Memory > Erase.

If the CTD-N is currently logging data, the CTD Logging window opens:

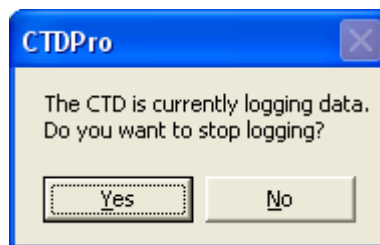

4. Click Yes to stop data logging, or click No to continue.

If you click No, the window closes and data acquisition continues without interruption.

If you click yes, data logging stops, the window closes and the Erase Memory window opens:

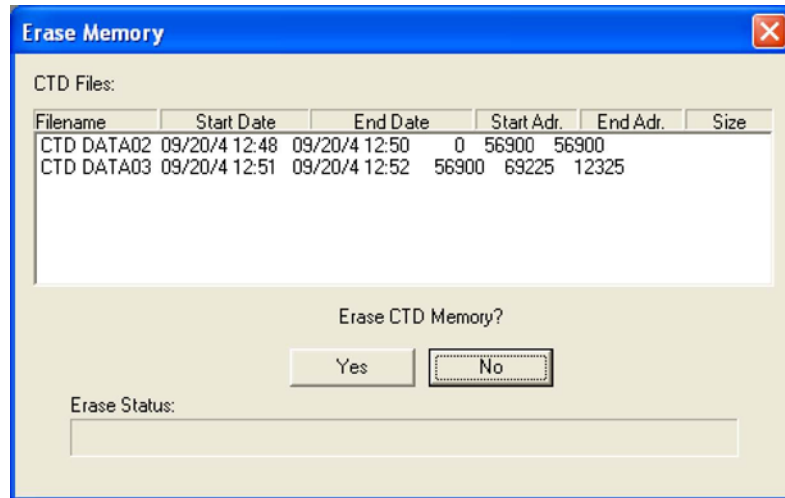

5. Click Yes to erase all of memory.

A CTDDPro window opens asking if you want to erase all of memory:

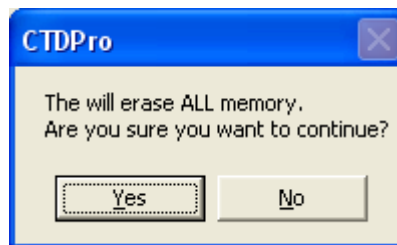

6. Click Yes to confirm that you want to erase all of memory.

The memory is erased as indicated by the Erase Status progress bar in the Erase Memory window, and then the Erase Memory window closes.

Acquiring, Displaying, and Saving Data in Real Time

Data acquired by the CTD-N can be displayed and saved in real time by running the instrument directly from the test cable, or the test cable can be replaced with a sea cable for running up and down casts or remotely deploying the instrument. (See [APPENDIX B: Bulkhead Connector Wiring](#) for information on the bulkhead connector wiring.) You can connect as many instruments as there are available serial ports on the computer, up to 16. For each instrument the data are displayed numerically in a table and as plots on a graph, and recording is directly to disk on your computer. The data are saved to a DAT file, a file of extension .dat, which is in ASCII format and can be opened and viewed in any text editor.



NOTE. Before deploying the CTD-N, you should run the diagnostic tests as described in [Running the Diagnostic Tests](#) with the test cable or sea cable that will be used in the deployment connected.

This section provides instructions on how to acquire data in real time and how to display and save the data.

Starting Data Acquisition

To start data acquisition and to save and display the data:

1. Choose Start > All Programs > RD Instruments > CTDPro.

CTDPro starts and the CTDPro Main window opens.

2. Choose CTD > Communications > Channels.

The Channel Configuration dialog box shown in Figure 37 opens.

3. In the Select Channels area of the Channel Configuration dialog box, select the parameters that you want to save and display.

4. Choose CTD > Acquisition.

The CTD-N Acquisition window shown in Figure 38 opens.

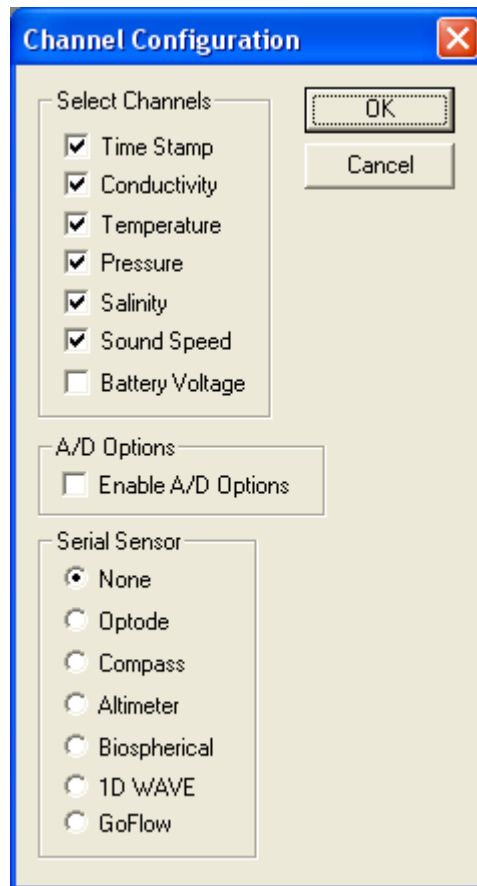

Figure 37. The Channel Configuration Dialog Box



NOTE. You can open as many CTD-N Acquisition windows as there are connected instruments. The instruments must connect to separate serial ports.

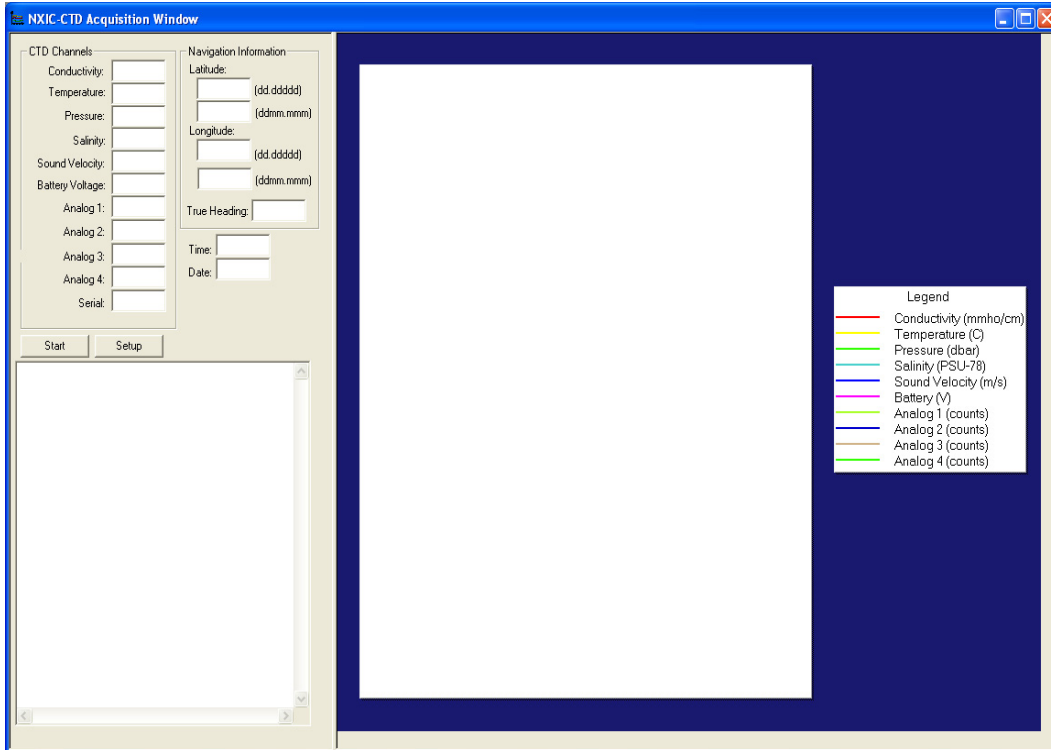



Figure 38. The CTD-N Acquisition Window

 **NOTE.** To view more of the Text Window in the CTD-N Acquisition window, click and drag the vertical window divider to the right or drag the scroll box in the horizontal scroll bar to the right.

5. In the CTD-N Acquisition dialog box, click Setup. The Acquisition Setup dialog box shown in Figure 39 opens.

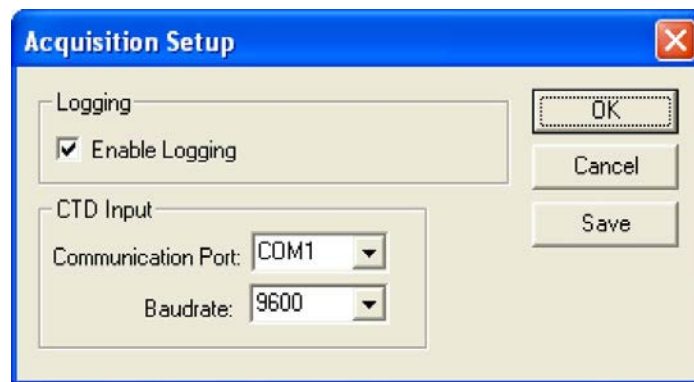

Figure 39. The Acquisition Setup Dialog Box

6. In the Logging area of the Acquisition Setup dialog box, select the Enable Logging check box if you want to save the data to a file.

7. In the CTD Input area, select the serial port to which the CTD-N is connected from the Communication Port drop-down list box.
8. Select the baud rate from the Baudrate drop-down list box.
9. Click OK to save the selections and close the Acquisition Setup dialog box.
10. Click Start.

The Save As Dialog Box for ASCII data files shown in Figure 40 opens. This dialog box is used to create the file in which to save the real-time data.

11. Click the arrow in the Save in drop-down list box and select the folder in which to save the data file.
12. In the File name text box enter the name of the file in which to save the data. The extension *.dat* is added automatically.
13. Click Save.

The Save As dialog box for ASCII data files closes and the data are displayed and saved in real time.

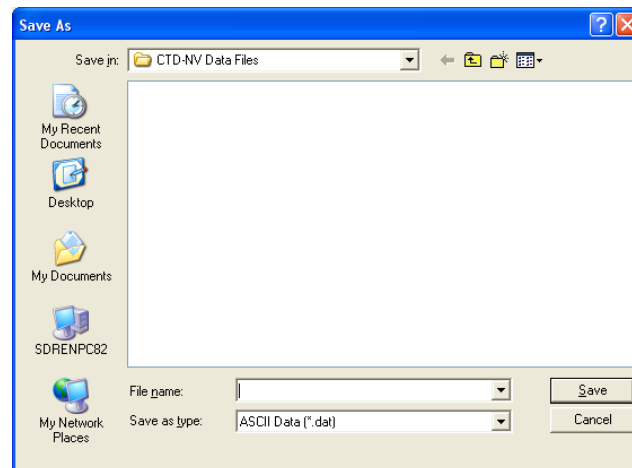

Figure 40. The Save As Dialog Box for ASCII Data Files

Stopping Data Acquisition

To stop data acquisition, click Stop in the CTD-N Acquisition window.

Viewing Saved Data

To view data that have been saved, choose File ► View Text File, select All Files from the Files of type drop-down list box in the Open dialog box, select the file, and then click Open. Or use Windows Explorer to navigate to the file and double-click it.

CTD-N Acquisition Window Displays

The CTD-N Acquisition window provides digital displays of the conductivity, temperature, pressure, salinity, and sound velocity data in the CTD Channels area of the window. The four analog channels, Analog 1 to Analog 4, and the RS-232 channel, Serial, are also displayed if optional external sensors are installed. The data are also displayed in tabular format in the Text Window and as plots in the graph. The graph includes a legend to identify the plots. In addition, if a GPS is connected as described in [Connecting and Setting up Communications with a GPS](#), the latitude, longitude and heading of the CTD-N is displayed in the Navigation Information area. Latitude and longitude are displayed both in degrees decimal and in degrees/minutes decimal. An example of real-time data displayed in the CTD-N Acquisition window is shown in Figure 41.

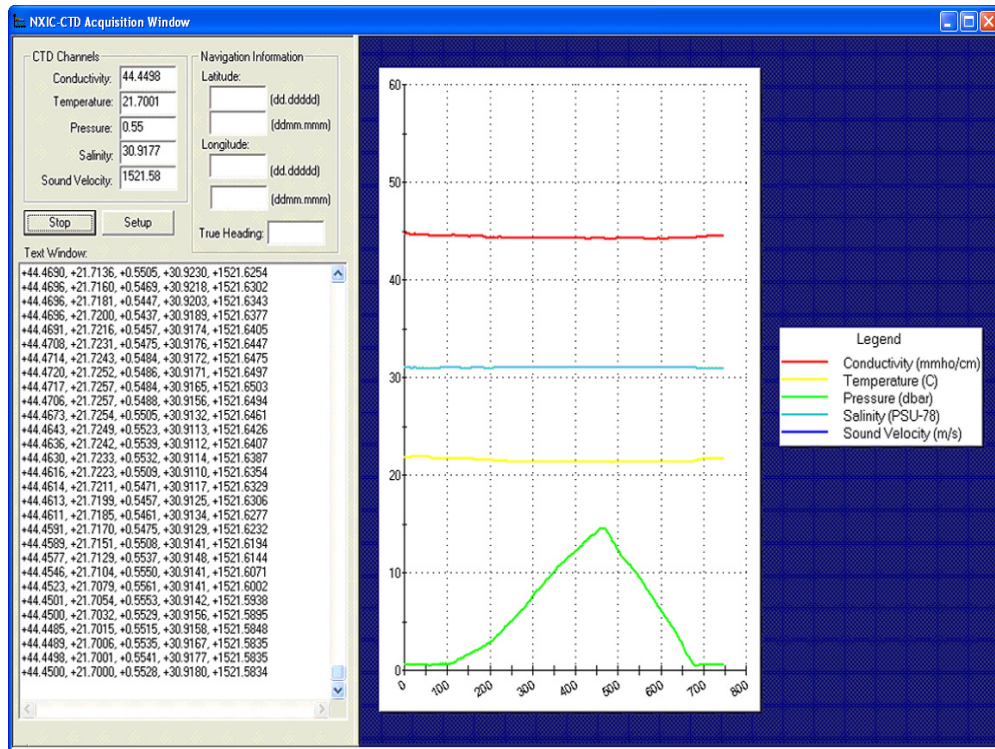

Figure 41. The CTD-N Acquisition Window with Real-Time Displays of Data



NOTE. You can zoom in on the graph in the same manner as described in [Zooming in and Out of a Graph](#), and you can set up the graph as described in [Setting up a Graph](#).

CTD-N Maintenance

To ensure your CTD-N continues to provide you with accurate data, you should inspect and clean the instrument after each use. This section provides some inspection and cleaning recommendations and instructions on how to replace the battery pack.

Recommended Maintenance

Table 2. Recommended Maintenance

User Maintenance	
Item	TRDI Recommended Period
Housings/End Caps	Inspect for damage and replace as required.
Hardware (bolts, nuts, washers, etc.)	Manufacturer recommends replacement after every deployment or every at least each year. Damaged hardware should never be used.
O-rings	Manufacturer recommends replacement every time the instrument is opened. Damaged O-rings should never be used.
Connector	Inspect for damage and replace as required. Damaged connectors should never be used.
Conductivity Sensor	Fill with oil prior to each deployment. Manufacturer recommends verification of reasonable performance before each deployment; i.e. a reference comparison.
Temperature	Manufacturer recommends verification of reasonable performance before each deployment; i.e. a reference comparison.
Pressure Sensor	Manufacturer recommends verification of reasonable performance before each deployment; i.e. a reference comparison.
Oil	Manufacturer recommends filling oil with capillary tube before every deployment.
Calibration*	
Item	TRDI Recommended Period
Conductivity Sensor	Manufacturer recommends return every 1 to 2 years for Factory calibration.
Temperature Sensor	Manufacturer recommends return every 1 to 2 years for Factory calibration.
Pressure Sensor	Manufacturer recommends return every 1 to 2 years for Factory calibration.

*The measurement error band of the CTD will widen over time due to component aging. This effect happens regardless of whether or not the instrument is being operated. Due to the stringent accuracy specifications, the effects of drift rapidly become a significant portion of the overall instrument error budget. For example, the error band for the conductivity measurement will reach twice its initial value three months after calibration. Periodic recalibration of the instrument is recommended to return to the original error band.

Factory Maintenance	
Item	TRDI Recommended Period
RTC Battery Replacement	3 to 4 years maximum: return to manufacturer for replacement.
Housing/End Caps	3 to 5 years maximum: return to manufacturer for inspection, shorter periods may be required depending on marine growth.
O-rings	3 to 5 years maximum: return to manufacturer for replacement.
Connector	3 to 5 years maximum: return to manufacturer for replacement.

Cleaning and Inspecting the CTD-N

To remove foreign matter and biofouling:

1. Remove soft-bodied marine growth or foreign matter with soapy water. Waterless hand cleaners remove most petroleum-based fouling. If there is heavy fouling or marine growth, TRDI recommends soaking the affected areas in a 50:50 bath of fresh water and apple cider vinegar for one to two hours to break down the shell-like parts. Use a wooden dowel to carefully break up larger pieces of the shells. Scrubbing with a medium stiffness brush usually removes the remaining soft-bodied parts.



Do NOT use power scrubbers, abrasive cleansers, scouring pads, high-pressure marine cleaning systems or brushes stiffer than hand cleaning brushes as this can scratch surfaces and damage softer parts like urethanes and sealants used in the construction of the system.

Do NOT use excessive force when breaking up larger pieces of shells or you risk damaging the sensitive components on the external or inside of the system.

2. Rinse with fresh water to remove soap or apple cider vinegar residue.
3. Repeat steps 1 – 3, as required to remove heavy marine growth.



Do NOT soak for longer than two hours at any time and always rinse with fresh water between soakings. Soaking for longer than two hours at a time can break down the urethane and other sealants used in the construction of the system.

4. Dry the system with low-pressure compressed air or soft lint-free towels.



Do NOT use high pressure or you may damage softer surfaces.

Always dry the system before placing it in the storage case to avoid fungus or mold growth.

After cleaning the instrument, check it carefully for signs of damage. Check the bulkhead connector for looseness or other signs of damage. Check the pins of the bulkhead connector. They should be kept clean at all times. Clean the connector pins and sockets with an alcohol wipe, and when reconnecting, lubricate the rubber portion of the pins with an O-ring quality silicone based lubricant. If one or more optional sensors are installed, the end cap includes, in addition to the 6-pin bulkhead connector, an Options 1 and Options 2 connector. For information on these connectors and the optional sensors, refer to [APPENDIX C: Optional Sensors](#).

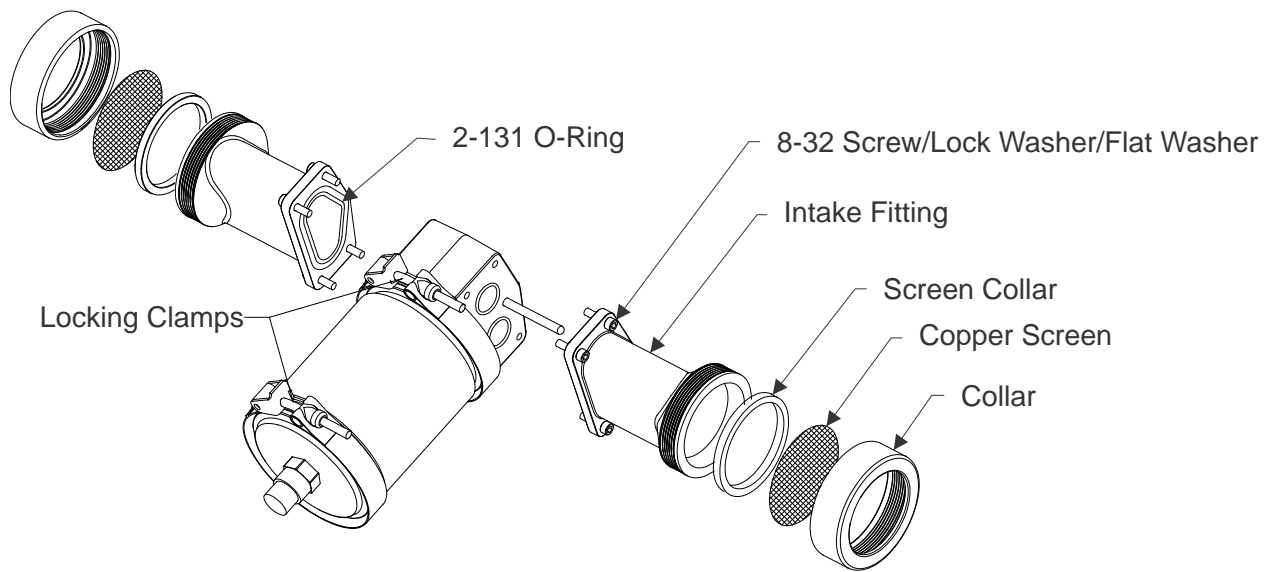

Figure 42. Cleaning the CTD-NH Sensor Head



Notice how there is no marine growth on the copper screens.

Photo by OceanNetConsulting, Spain

Replacing the Battery Pack

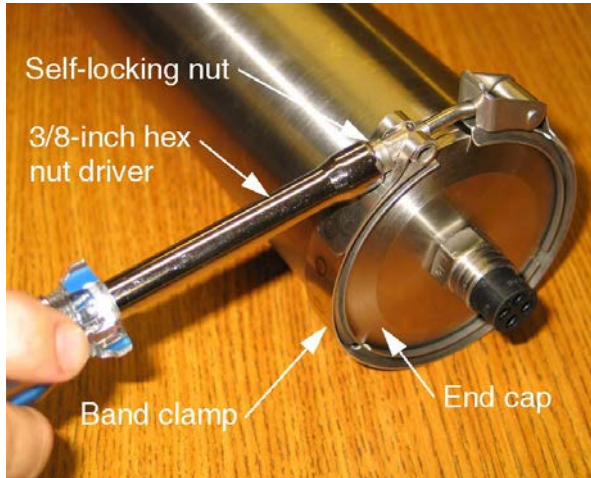

Loosening the Self-Locking Nut on the Band Clamp

Replacing the battery pack requires removal and reinstallation of the end cap on the instrument housing.

To replace the battery pack:

1. Using a 3/8-inch hex nut driver, loosen the self-locking nut on the band clamp that secures the end cap as shown.



Caution label on housing



As with all high pressure instrumentation, observe caution while using the CTD-N or after exposing it to high pressures. Wear safety glasses and keep head and body clear of the end-cap while opening.



Releasing the Band Clamp Catch

2. Release the band clamp catch as shown, and then remove the band clamp by spreading the band slightly and sliding it over the end cap.



Removing the End Cap

3. Carefully remove the end cap by grasping the housing in one hand and the end cap connector in the other as shown and pulling straight out. It may be necessary to twist the end cap slightly while pulling. If necessary, a flat plastic, nonmetallic tool can be used to pry the end cap from the housing.



Do not use a sharp metallic object, such as a screwdriver or putty knife, to pry open the end cap as damage to the end cap, housing or O-ring could occur.

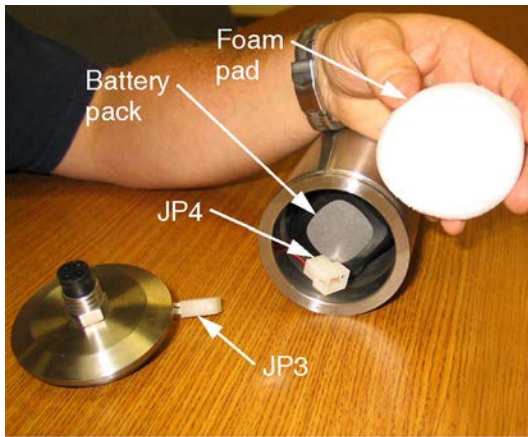

Disconnecting the JP3 and JP4 In-Line Connectors

4. Disconnect the in-line connectors JP3 and JP4 and remove the foam pad as shown, exposing the battery pack.

If the Option 1 and Option 2 connectors are installed, refer instead to the next photo.

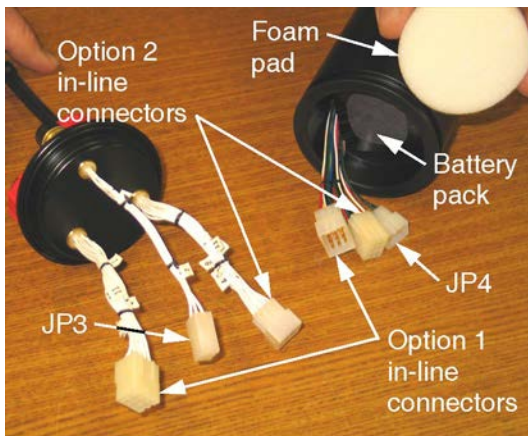

Disconnecting the JP3 and JP4 In-Line Connectors, with Options Connectors



The Option 1 and Option 2 in-line connectors are shown disconnected for identification purposes. You do not have to disconnect these connectors if you are only replacing the battery pack.

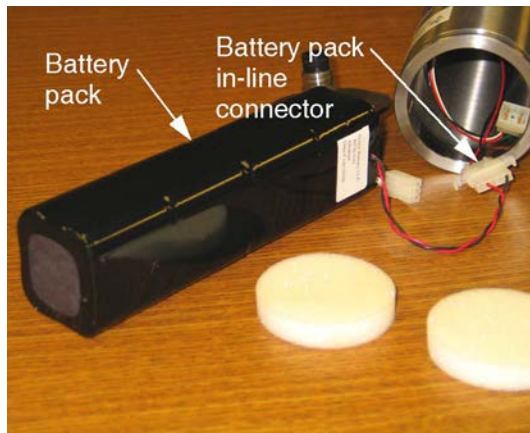

Removing the Battery

5. Remove the battery pack and another foam pad as shown.

6. Disconnect the battery pack in-line connector, and then connect a fresh battery pack.

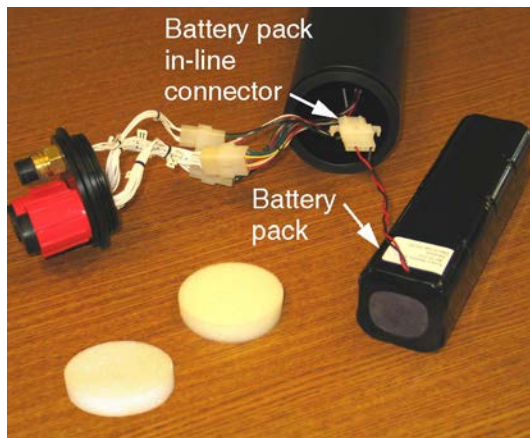

Removing the Battery, with Options Connectors

If the Option 1 and Option 2 connectors are installed, refer instead to this photo.

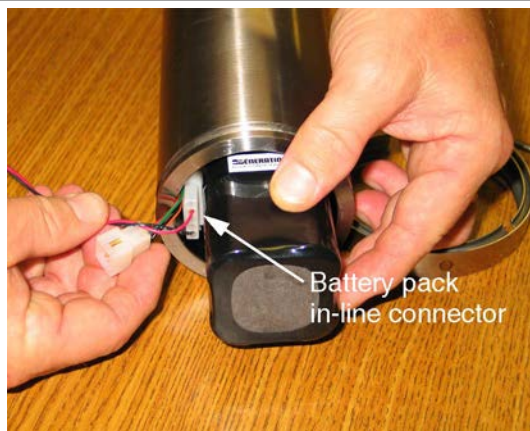

Inserting a Battery

7. Insert a foam pad followed by the battery pack, wire end first, part way into the housing. Then insert the battery pack in-line connector between the housing and the battery pack as shown.

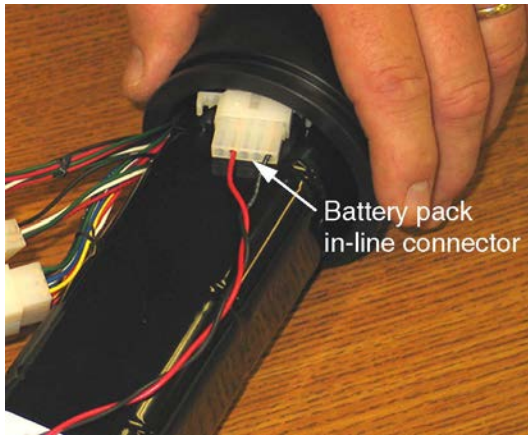

Inserting a Battery, with Options Connectors

If the Option 1 and Option 2 connectors are installed, refer instead to this photo.

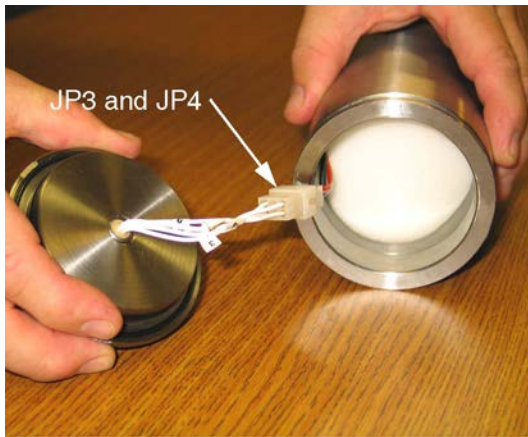

Connecting the JP3 and JP4 In-Line Connectors

8. Push the battery pack into the housing as far as it will go, and then insert the second foam pad over the battery pack and connect the in-line connectors JP3 and JP4 as shown.

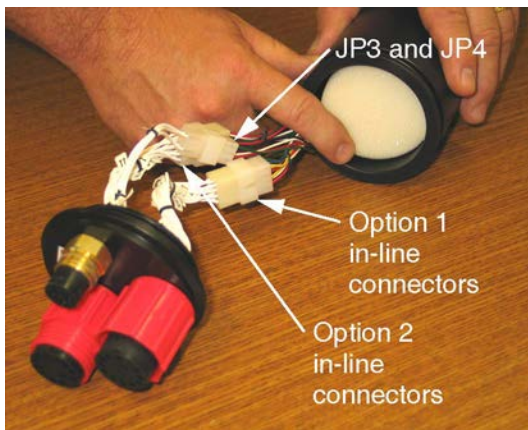

Connecting the JP3 and JP4 In-Line Connectors, with Options Connectors

If the Option 1 and Option 2 connectors are installed, refer instead to this photo.



NOTE. There are two O-rings installed in the O-ring groove on the end cap: a backing O-ring, which has a flat side and a round side, and a standard round O-ring. As shown below, the backing O-ring is installed with the flat side facing toward the inside of the housing and the round side facing toward the outside of the housing. The round O-ring is installed against the round end of the backing O-ring.

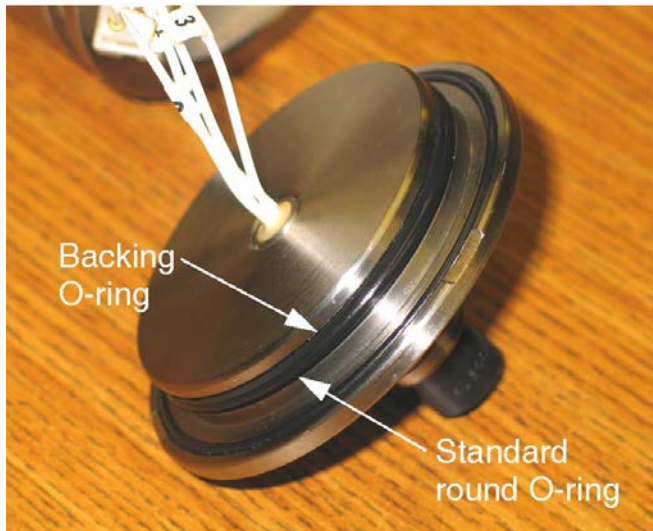

Backing and Standard Round O-rings Installed in O-ring Groove in End Cap

9. If nicks or scratches are found on an O-ring, replace it. When replacing the O-ring, first clean the O-ring surface on the end cap with a lint-free cloth. Then lightly lubricate the new O-ring with silicone grease and install it onto the end cap.

10. Press the end cap into the housing, being careful not to pinch the wires.

11. Spread the band clamp slightly, and then install it over the end cap and housing such that it straddles the groove in the housing and the lip of the end cap, holding the housing and end cap together.

12. Latch the band clamp catch, and then tighten the self-locking nut until it is snug. Do not over-tighten.

Oil Fill Procedure and Capillary Tube Installation



NOTE. The following procedure is for units with pressure sensors only.

The pressure sensor used in your instrument is exposed to ambient pressure through a pressure port and an oil-filled capillary. The oil provides the required pressure coupling and is an electrical insulator that prevents corrosion due to the dissimilar material compositions of the transducer and instrument housing.

Included with your instrument is a capillary tube installation kit. The following procedure will provide guidance to allow you to install the capillary onto the instrument.

Should you require further assistance please do not hesitate to contact Teledyne RD Instruments and ask to speak to a customer service representative.

The following parts should be included in your kit:

Part Number	Quantity	Description
1400-65361	1	Nalgene Bottle
5400-7510A653	1	Syringe
5400-TS19X1	1	Needle
NY-200-1-2ST	1	Capillary Body Assembly
A150-045	1	Capillary Tube
1605-378372	1 ounce	Oil, Dow Corning 200 CTS
97F-6003-00	1	Needle Cover
AN2005001	1	Oil Fill Procedure

Should you require additional parts from this kit please contact a Teledyne RD Instruments sales representative. Please have the part number on hand to acquire price and delivery information.



Step #1:

Place the instrument on a flat surface with the pressure port cavity pointed up.



Step #2:

Assemble the syringe and insert a small amount of oil from the Nalgene bottle into the syringe. Fill the pressure port cavity to the top with the oil.

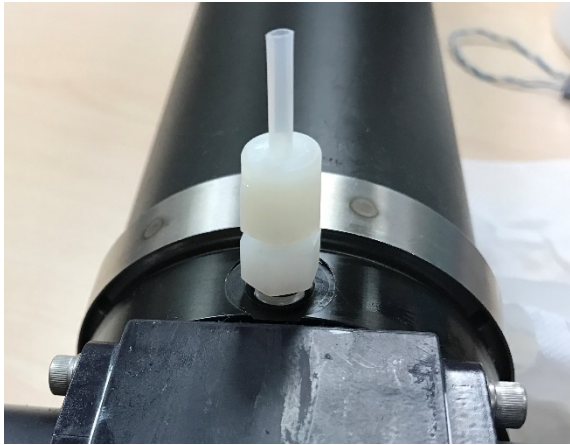

Step #3:

Thread the capillary assembly into the pressure port slowly. You should see the oil wick up into the capillary tube as you thread the assembly into the end cap.

Have an absorbent paper towel on hand to clean up any overflow that you may have.



Step #4:

Continue threading the assembly until the threads are no longer exposed and the O-ring is seated onto the end cap.

Have an absorbent paper towel on hand to clean up any overflow that you may have.



Step #5:

Using hands only, tighten the assembly onto the end cap to four inch-pounds.

***** HAND TIGHTEN ONLY! *****

***** MAXIMUM 4 INCH-POUNDS TORQUE *****

***** DO NOT OVERTIGHTEN *****

Have an absorbent paper towel on hand to clean up any overflow that you may have.

If no oil is observed in the capillary tube repeat steps 1-5.

The installation is complete and the instrument is ready to be deployed.

Installing a CTD-N End Cap Switch Kit

This section illustrates how to replace the original CTD-N end cap with a new end cap that contains a shorting plug. The shorting plug allows the battery power to be connected and disconnected without having to open the CTD-N.

The CTD-N End cap Switch Kit gives the user the ability to easily connect and disconnect the CTD-N internal battery. The original 4-pin bulkhead is replaced with a 6-pin bulkhead connector. When the 6-pin bulkhead is open or the dummy plug is connected there is no power drawn from the battery. Plugging in the Battery Shorting plug or the Battery Adapter cable draws battery power. If external power is applied the battery does not supply power.

Check Contents of Package

There are four different CTD-N End-cap Switch Kits. These kits differ only by the end-cap that is supplied with each kit; all other contents are the same. Use Figure 43 to verify that the Switch Kit is complete. If there are any parts missing call TRDI for a replacement.

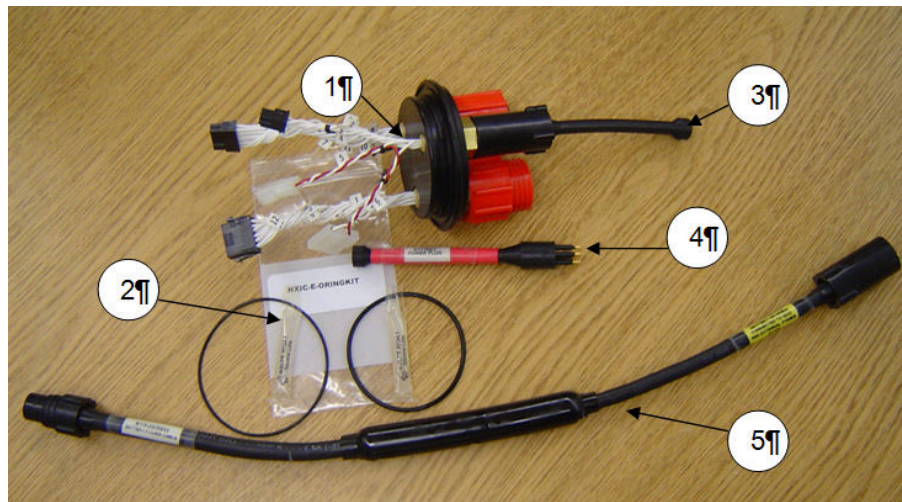

Figure 43. Contents of NXIC CTD End-cap Switch Kit:

(1) End-cap Assembly (e.g. NXICADC-SESKIT) (2) O-ring kit, (3) Dummy Plug
(4) Shorting Plug (5) Battery Adapter Cable.

Table 3: NXIC End cap Switch Kit Contents

Part Number	Description	Quantity
NXIC-E-ORINGKIT	Contains two O-rings and one packet of silicone O-ring grease. The O-ring with the larger diameter is used for the end-cap's face-seal and the smaller diameter O-ring is used for the end-cap's piston-seal.	1
2106-DCMC6M	A 6-pin open dummy plug	1
A176-206	A 6-pin shorting plug used to connect battery power.	1
B176-207	A 20-inch cable with a 6-pin male connector to a 4-pin female connector to connect to the standard NXIC test cable. This cable also connects the battery and will draw battery power unless external power is applied.	1

Remove original end cap with 4-pin bulkhead connector

1. Using a 3/8-inch hex nut driver, loosen the self-locking nut on the band clamp that secures the end cap
2. Release the band clamp catch and then remove the band clamp by spreading the band slightly and sliding it over the end cap.
3. Lift the original end-cap off by pulling on the bulkhead connectors; a slight rocking action is useful to free the end-cap. Do not use a metal tool to pry the end-cap off, as it may scratch the O-ring surface.
4. Disconnect all inline connectors from the end-cap.

Assemble new end cap with 6-Pin Bulkhead connector

1. Mount O-Rings into O-Ring Grooves of New End cap. O-rings must be free of dirt and debris to work properly. Clean the O-rings on the end cap and the O-ring surface on the housing with a lint-free cloth or paper towel. Carefully inspect the O-rings for any nicks or scratches. If nicks or scratches are found on an O-ring, replace it. Lightly lubricate the new O-rings with silicone grease and install it onto the end cap.
2. Reconnect the Electrical Connections. All connectors are uniquely keyed and will only connect one way.
3. Press the end cap into the housing, being careful not to pinch the wires. Watch that the face-seal O-ring stays within the face-seal groove.
4. Spread the band clamp slightly, and then install it over the end cap and housing such that it straddles the groove in the housing and the lip of the end cap, holding the housing and end cap together.
5. Latch the band clamp catch, and then tighten the self-locking nut until it is snug. Do not over tighten.

Test new end cap assembly

1. Connect the battery adapter cable to the new end cap and a standard test cable to the adapter. The unit should operate normally. Refer to [Using the CTD-N End Cap Switch](#) for more information on using the new battery switch.

Firmware Updates

This section shows how to update the firmware for your CTD-N series instruments.



NOTE. If you currently have a firmware version earlier than version 3.0, please contact TRDI for assistance.

1. To determine what firmware version your NXIC unit is currently running, open the terminal window in CTDDPro while communicating with the NXIC unit. Enter Open mode (**O), and type VER. Press Enter, as shown in the screen shot below.

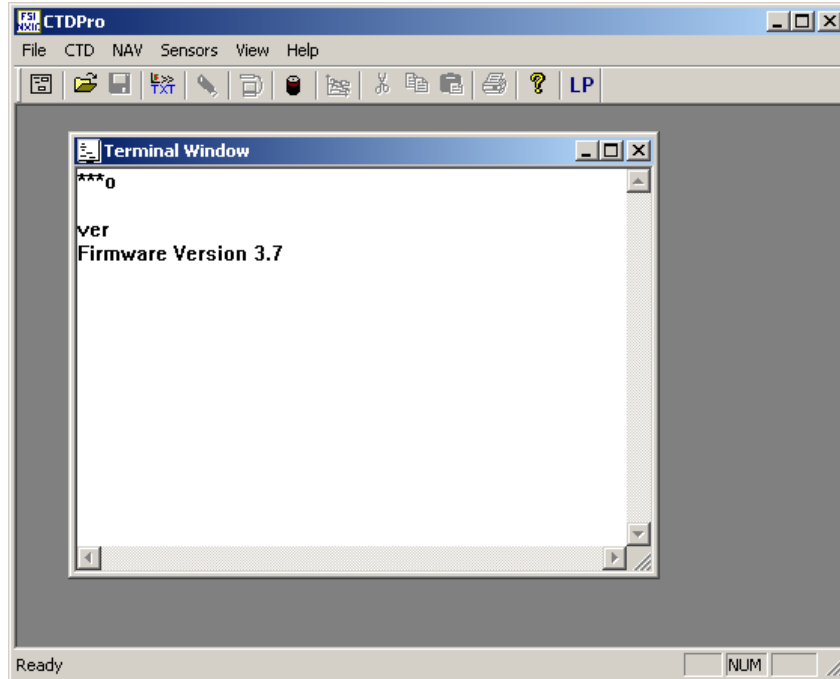

2. Set the baud rate of the CTD-N to 9600 baud by using CTDPro.
3. Download the CTD-N firmware to your desktop: Use our online customer portal at <http://www.teledynemarine.com/rdi> and click on the **Support** link. Log into your account and then click the **Software/Firmware** link.
4. Double-click on the exe file.
5. Click the **Setup** button.

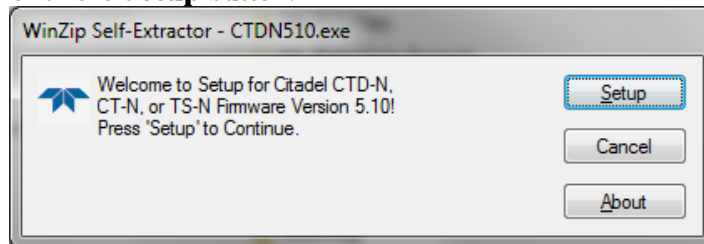

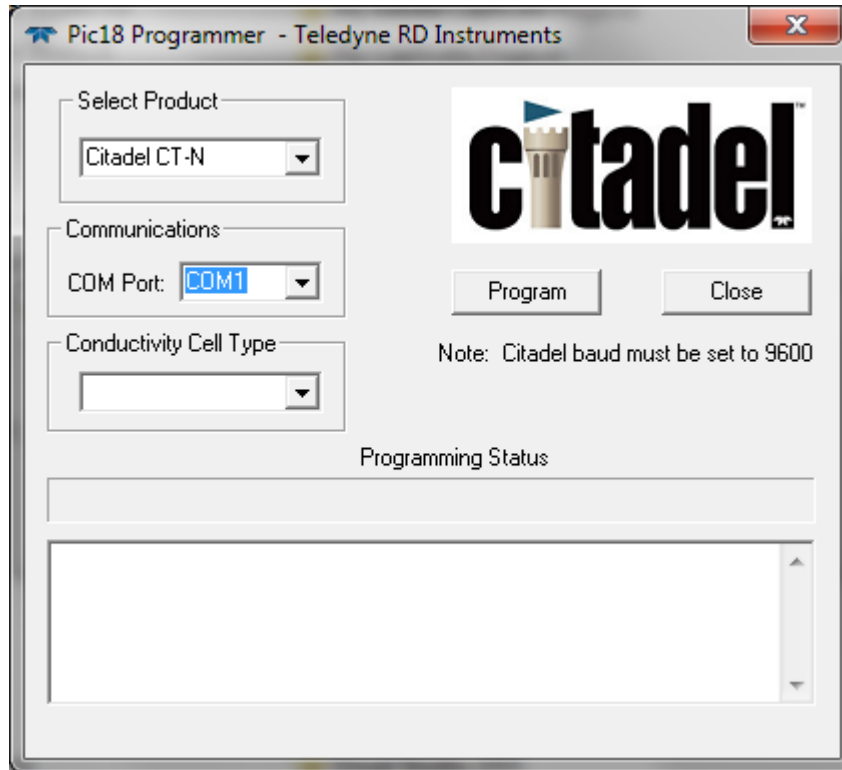

Figure 44. CTD-N Firmware Updates

6. Set the **Select Product** box to **Citadel CTD-N** and select the **COM Port** that your CTD-N is connected to.
7. Click the **Program** button and wait until the **Programming Status** meter is full (this takes approximately 5 minutes).
8. A window that reads *Programming complete* will pop up. Click **OK** on this window and then click on the **Close** button on the Pic18 Programmer window to exit.

APPENDIX A:

Measured and Calculated Parameters

Conductivity, temperature, and pressure are measured directly by the CTD-N. In addition, the instrument calculates salinity and sound velocity. All these parameters are recorded to internal memory along with the time and date and the battery voltage for each sample, and they are retrieved when downloading the data from the instrument and saving the data to a file. When exporting the saved data to a text or spreadsheet file, or to CTDPost, CTDPro can calculate additional parameters from the measured parameters. Any combination of the measured and calculated parameters, including those calculated by CTDPro, can be exported. (See [Exporting Saved Data](#) for instructions on how to export data to a file.)

Parameters Measured by the CTD-N

The parameters directly measured by the CTD-N are the following:

Conductivity:	The measured water conductivity in mS/cm.
Temperature:	The measured water temperature in °C.
Pressure:	The measured water pressure in dbars.
Battery Voltage:	The measured battery voltage in volts.

Parameters Calculated by the CTD-N

The parameters calculated by the CTD-N are following:

Salinity:	The seawater salinity in accordance to PSS78 (Practical Salinity Scale 1978).
Sound Velocity:	The sound velocity in water in m/sec.
Time and Date:	The time in hours, minutes and seconds, and the date in month, day and year on which the selected parameters are output and stored for each sample.

Parameters Calculated by CTDPro

The parameters calculated by CTDPro are the following:

Depth:	The water depth in meters.
Density:	The water density in kg/m ³ .
Salinity:	The seawater salinity in accordance to PSS78 (Practical Salinity Scale 1978).
Sound Velocity: T	The sound velocity in water in m/sec.
Potential Temperature:	The water temperature without the effects of pressure in °C.
Adiabatic Temperature Gradient:	The water adiabatic temperature gradient in °C/dbar.

APPENDIX B:

Bulkhead Connector Wiring

The CTD-N includes a SubConn® bulkhead connector on the lower end cap for connecting to a computer and to power. This connector and its associated components are listed in Table 4.

Table 4: Bulkhead Connector Components

ITEM	SubConn PART NUMBER	TRDI PART NUMBER
Bulkhead Connector	MCBH4F	2106-MCBH4F
Pigtail	MCIL4M	2106-MCIL4M
Dummy Plug	MCDC4M	2106-MCDC4M
Locking Sleeve	MCDLSF	2106-MDLSF

Refer to Table 6 for the required connections from the bulkhead connector to the computer, and to Table 7 for the connections from the connector to the power supply. Figure 45 shows the bulkhead connector pin orientation as viewed from the face.



NOTE. Consult the table below or the SubConn website (<http://www.subconn.com>) for color code of the wires in the connecting pigtail. Pigtails and custom cables are available directly from TRDI.

Table 5: Pigtail Color Codes/Functions

PIN	COLOR	RS-232	RS-485	TTL
1	BLACK	GROUND	GROUND	GROUND
2	WHITE	RXD	RS-485A	RXD
3	RED	+ POWER	+POWER	+POWER
4	GREEN	TXD	RS-485B	TXD

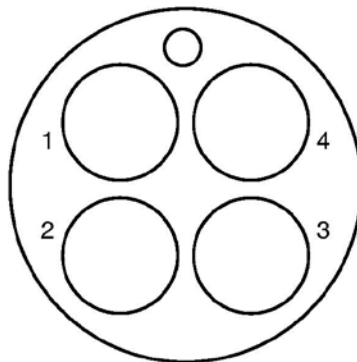

Figure 45. 4-pin Bulkhead Connector Face View

Table 6: CTD-N Bulkhead 4-pin Connector to Computer Connections

PIN	LABEL	FUNCTION
1	GND	Ground
2	RXD/RS-485A	Received Data from Computer
4	TXD/RS-485B	Transmitted Data to Computer

Table 7: CTD-N Bulkhead 4-pin Connector to Power Supply Connections

PIN	LABEL	FUNCTION
1	GND	Ground
3	Power(+)	Instrument Power



NOTE. The 4-pin connector is used on Direct Reading CTD-N units only.

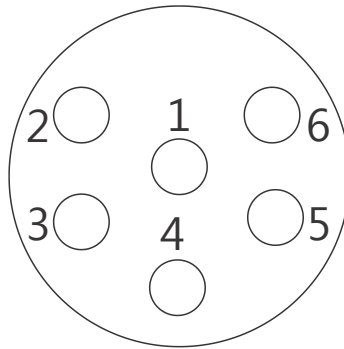

Figure 46. 6-Pin Bulkhead Connector Face View

Table 8: CTD-N 6-pin Bulkhead Connector to Computer Connections

PIN	LABEL	FUNCTION
1	GND	Ground
2	RXD/RS-485A	Received Data from Computer
4	TXD/RS-485B	Transmitted Data to Computer
5	BAT SWITCH	Battery Switch
6	BAT SWITCH	Battery Switch

Table 9: CTD-N 6-pin Bulkhead Connector to Power Connections

PIN	LABEL	FUNCTION
1	GND	Ground
3	Power(+)	Instrument Power



NOTE. The original 4-pin bulkhead connector is replaced with a 6-pin bulkhead connector when the CTD-N includes the External Sensor Interface, battery, or the End Cap Switch Kit. The optional End Cap Switch Kit gives the user the ability to easily connect and disconnect the internal battery.

Table 10: Test Cable Pin Out

CONNECTOR	PIN	RS-232	RS-485
DB-9	2	RXD	RS-485A
DB-9	3	TXD	RS-485B
DB-9	5	DATA GROUND	DATA GROUND
POWER JACK	Internal	+ POWER	+POWER
POWER JACK	External	GROUND	GROUND

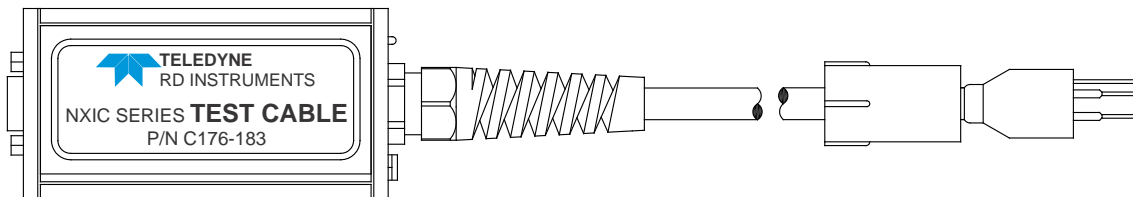
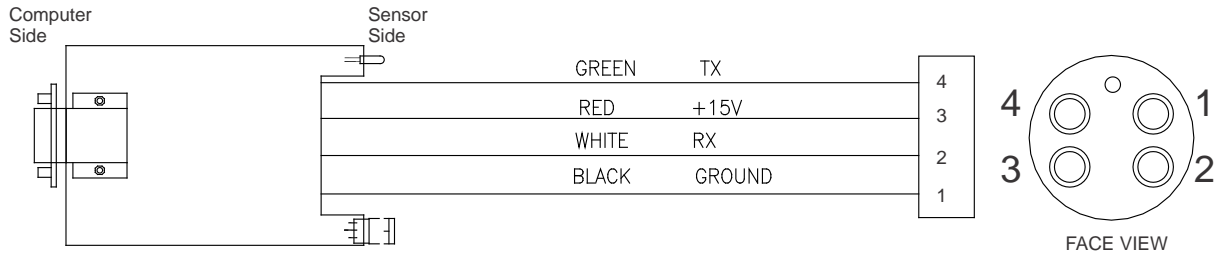

Figure 47. Test Cable Wiring



NOTE. This test cable is used with both RS232 and RS485 systems. The RS485 systems use a converter between the test cable power box and the computer.

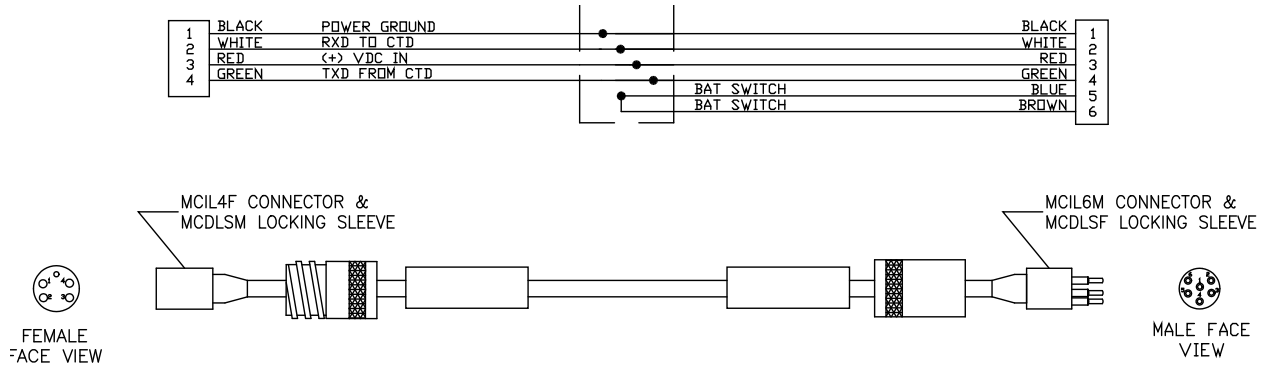

Figure 48. Battery Adapter Cable Wiring P/N B176-207

APPENDIX C:

Optional Sensors

The Citadel CTD has two types of sensors: Internal Sensors and External Sensors. The Internal Sensors are built into the system, and the External Sensors are optional ADC sensors attached to the optional ADC End Cap.

The External Sensor channels are listed with the [ROP command](#):

```
ROP
CHID1=0
CHID2=0
CHID3=0
CHID4=0
CHID5=0
```



NOTE. External Sensors 1-4 are A/D Channels and these channels are dedicated for Analog External Sensors. Channel 5 is dedicated for Digital External Sensors.

The CTD-N with the optional ADC End Cap includes two 12-pin bulkhead connectors together with the 6-pin bulkhead connector on the lower end cap as shown in Figure 49. These are the Option 1 and Option 2 connectors which are used to connect to optional external sensors. The Option 1 connector is specifically provided for connecting to Seapoint turbidity and fluorometer sensors. It outputs power and gain control signals to the sensors and inputs the sensor signals. The Option 2 connector provides power, two 0–5 VDC input channels and one RS-232 serial interface. The Option 1 connector is identified by its female locking collar; the Option 2 connector, by its male locking collar.



NOTE. The power available for the external sensors is 11 VDC nominal at 50 mA maximum for any sensor; 150 mA maximum total is available for all the sensors.

The Option 1 and Option 2 connectors and their associated components are listed in Table 11. Figure 49 shows the pin orientation for the two connectors, and the connector wiring information is shown in Table 12 for the Option 1 connector and Table 13 for the Option 2 connector.

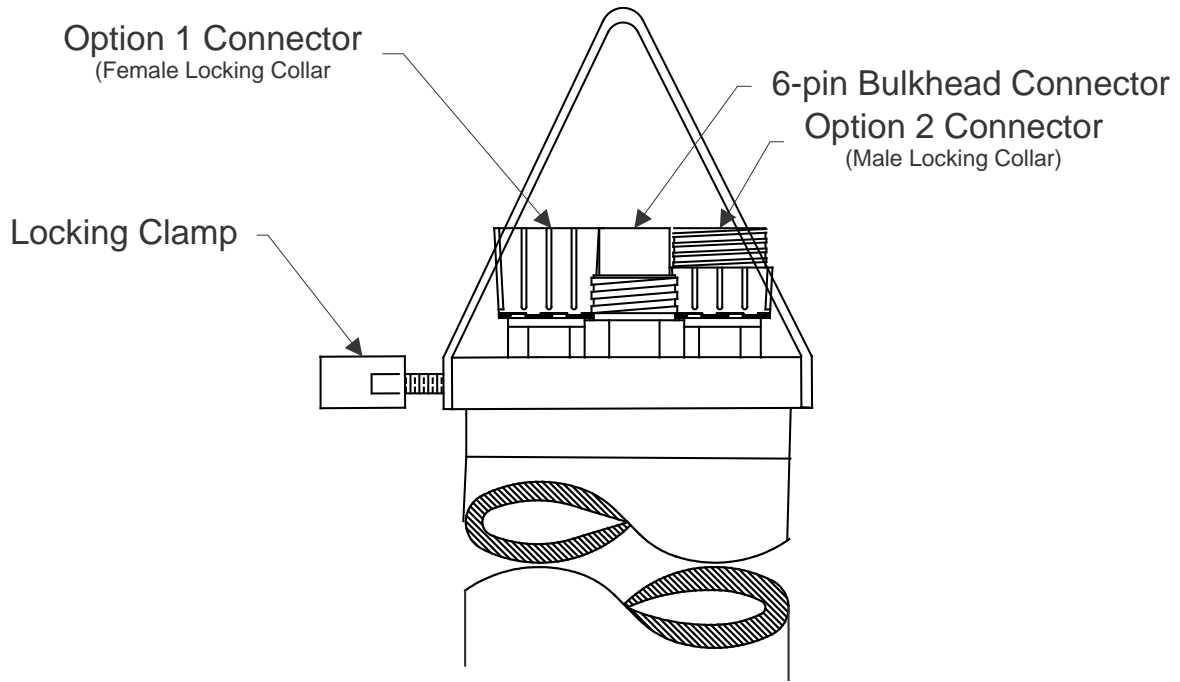

Figure 49. Option 1 & Option 2 Connectors with 6-pin Connector on Lower End Cap

Table 11: Option Connectors Components

ITEM	SUBCONN PART NUMBER	TRDI PART NUMBER
Bulkhead Connector	MCBH12F	2106-MCBH12F
Pigtail	MCIL12M	2106-MCIL12M
Dummy Plug	MCDC12M	2106-MCDC12M
Locking Sleeve (male)	DLSA-M	2106-DLSA-M
Locking Sleeve (female)	DLSA-F	2106-DLSA-F

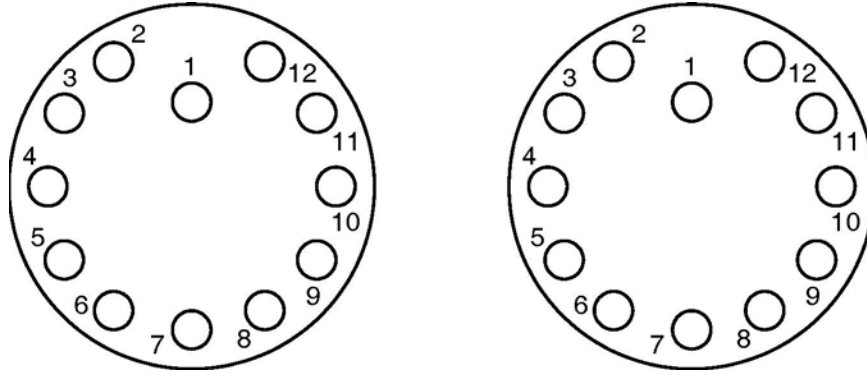

Figure 50. Option 1 and Option 2 Connectors Face View

Table 12: Option 1 Connector Connections

PIN	Channel	LABEL	FUNCTION
1	DC Channel 1	GND	Power Ground
2		Signal (+)	Sensor Signal
3		Power (+)	Sensor Power
4		Signal (-)	Sensor Signal Ground
5		Gain0_0	Gain Control A
6		Gain0_1	Gain Control B
7	DC Channel 2	GND	Power Ground
8		Signal (+)	Sensor Signal
9		Power (+)	Sensor Power
10		Signal (-)	Sensor Signal Ground
11		Gain1_0	Gain Control A
12		Gain1_1	Gain Control B

Table 13: Option 2 Connector Connections

PIN	Channel	LABEL	FUNCTION
1	DC Channel 3	GND	Power Ground
2		Signal (+)	Sensor Signal
3		Power (+)	Sensor Power
4		Signal (-)	Sensor Signal Ground
5	DC Channel 4	GND	Power Ground

6		Signal (+)	Sensor Signal
7		Power (+)	Sensor Power
8		Signal (-)	Sensor Signal Ground
9	RS-232 Channel 5	GND	Power Ground
10		RXD	Received Data
11		Power (+)	Sensor Power
12		TXD	Transmitted Data

Seapoint Turbidity Sensor

The turbidity sensor is a Seapoint Turbidity Meter manufactured by Seapoint Sensors, Inc. The sensor detects the light scattered by suspended particles in water and outputs a voltage proportional to the amount of suspended solids. The turbidity sensor is shown connected to the Options 1 connector on a CTD-N in Figure 51.

The turbidity sensor has four range selections which allow you to choose the best resolution for measuring clean to very turbid water. You can select the range in CTDPro by choosing the corresponding gain in accordance with Table 14. CTDPro also allows you calibrate the sensor by immersing it in several known standards.

For more information about the turbidity sensor, refer to the Seapoint Turbidity Meter user manual provided with the option.

Table 14: Seapoint Turbidity Sensor Range Selections

Gain	Resolution	Range
1X	2 mV/FTU	<750 FTU
5X	10 mV/FTU	500 FTU
20X	400 mV/FTU	125 FTU
100X	200 mV/FTU	25 FTU

Selecting the Range for the Seapoint Turbidity Sensor

To select the range for the turbidity sensor:

1. Connect the CTD-N to your computer.
2. Choose Start > All Programs > RD Instruments > CTDPro.

CTDPro starts and the CTDPro Main window opens.

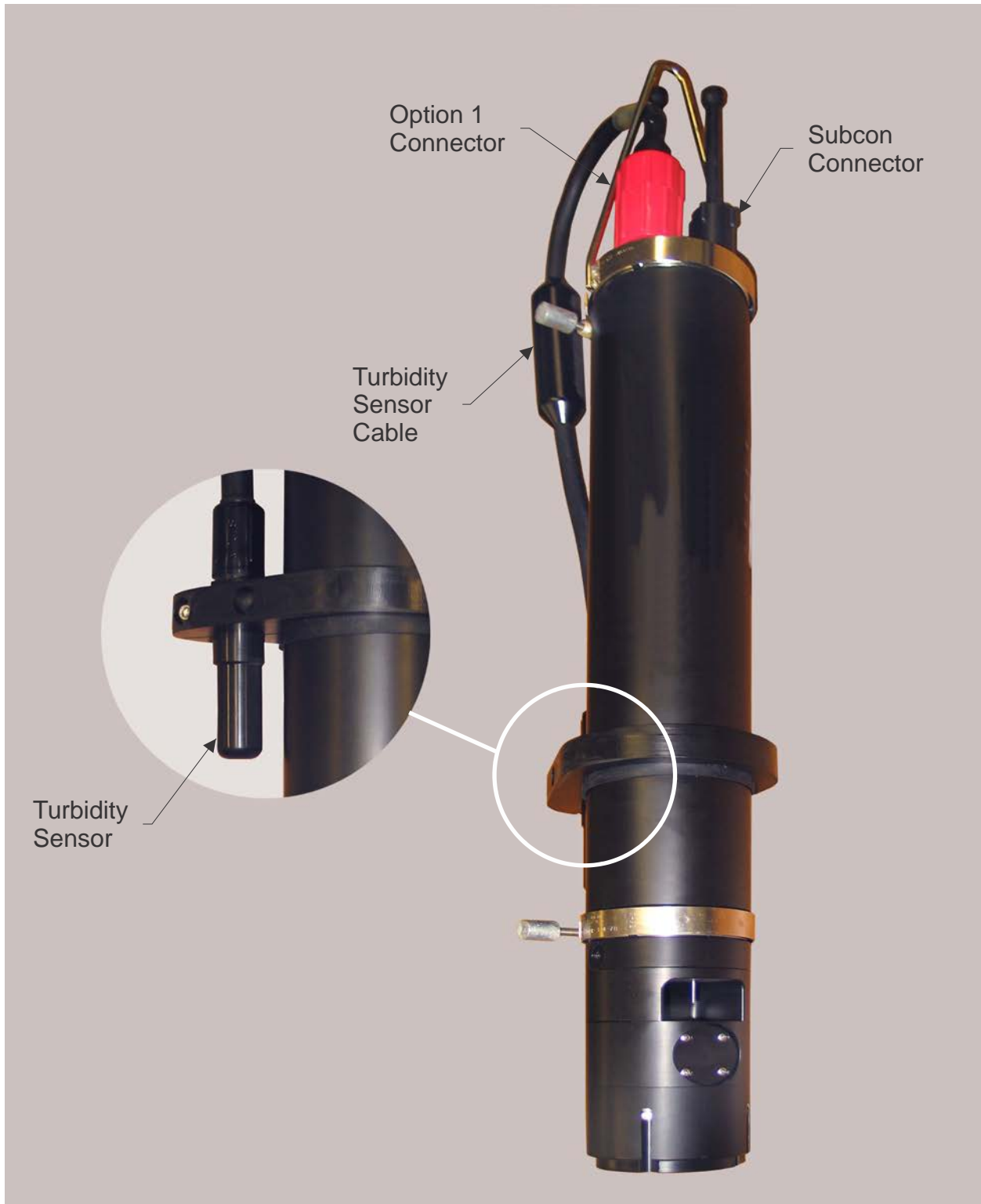
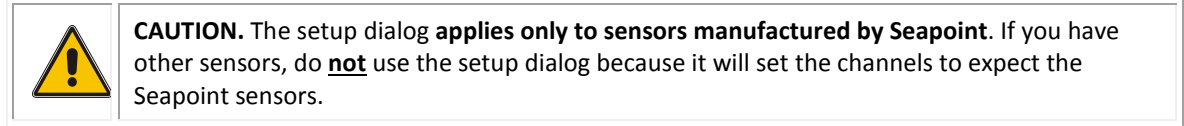

Figure 51. CTD-N with Seapoint Turbidity Sensor Connected to the Option 1 Connector

3. Choose Sensors > Setup.



The Sensor Setup dialog box shown in Figure 52 opens.

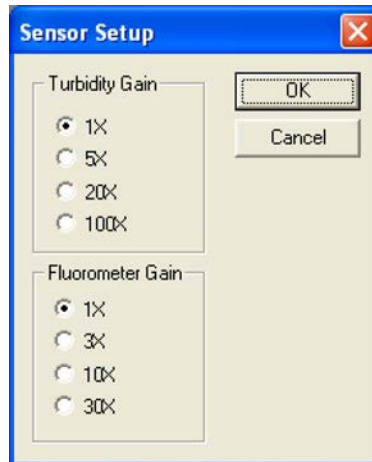

Figure 52. The Sensor Setup Dialog Box—Selecting Seapoint Turbidity Sensor Range

4. In the Turbidity Gain area of the Sensor Setup dialog box, select the desired option in accordance with Table 14.
5. Click OK to close the Sensor Setup dialog box and save the range setting.

Calibrating the Seapoint Turbidity Sensor

Before calibrating the Seapoint turbidity sensor, select the desired range as described in [Selecting the Range for the Turbidity Sensor](#).

To calibrate the turbidity sensor, refer to [Calibrating the External Sensors](#).

Seapoint Fluorometer Sensor

The fluorometer sensor is a Seapoint Chlorophyll Fluorometer manufactured by Seapoint Sensors, Inc. The sensor measures chlorophyll *a* over a wide dynamic range in a wide variety of conditions. The fluorometer sensor connects to the Options 1 connector on a CTD-N.

The fluorometer sensor has four range selections which allow you to choose the best resolution for the application. You can select the range in CTDPro by choosing the corresponding gain in accordance with Table 15. CTDPro also allows you calibrate the sensor by immersing it in several known standards.

For more information about the fluorometer sensor, refer to the Seapoint Chlorophyll Fluorometer user manual provided with the option.

Table 15: Fluorometer Sensor Range Selections

Gain	Resolution	Range
1X	0.033 V/($\mu\text{g/l}$)	150 $\mu\text{g/l}$
3X	0.1 V/($\mu\text{g/l}$)	50 $\mu\text{g/l}$
10X	0.33 V/($\mu\text{g/l}$)	15 $\mu\text{g/l}$
30X	1.0 V/($\mu\text{g/l}$)	5 $\mu\text{g/l}$

Selecting the Range for the Seapoint Fluorometer Sensor

To select the range for the Seapoint fluorometer sensor:

1. Connect the CTD-N to your computer.
2. Choose Start > All Programs > RD Instruments > CTDPro.

CTDPro starts and the CTDPro Main window opens.

3. Choose Sensors > Setup.



CAUTION. The setup dialog **applies only to sensors manufactured by Seapoint**. If you have other sensors, do **not** use the setup dialog because it will set the channels to expect the Seapoint sensors.

The Sensor Setup dialog box shown in Figure 53 opens.

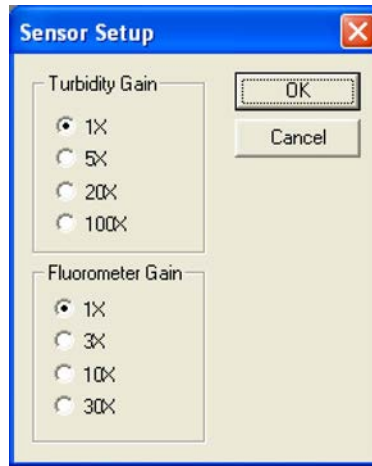

Figure 53. The Sensor Setup Dialog Box—Selecting Seapoint Fluorometer Sensor Range

4. In the Fluorometer Gain area of the Sensor Setup dialog box, select the desired option in accordance with Table 15.
5. Click OK to close the Sensor Setup dialog box and save the range setting.

Calibrating the Seapoint Fluorometer Sensor

Before calibrating the fluorometer sensor, select the desired range as described in [Selecting the Range for the Fluorometer Sensor](#).

To calibrate the fluorometer sensor, refer to [Calibrating the External Sensors](#).

Calibrating the External Sensors

CTDPro allows you to calibrate optionally installed external sensors. You must provide the means to set up the sensor to expose it to stimuli at its low and high range of operation and, if required, points in between. If the external sensor to be calibrated is a Seapoint turbidity or fluorometer sensor, select the desired range as described in [Selecting the Range for the Turbidity Sensor](#) or [Selecting the Range for the Fluorometer Sensor](#) before calibrating the sensor. Note that this step is not required for fluorometers or turbidity sensors by other manufacturers.



NOTE. You can also select the desired range by setting the Channel 1 (turbidity sensor) Gain_0 and Gain_1 outputs, or the Channel 2 (fluorometer sensor) Gain_0 and Gain_1 outputs. For instructions on how to make these settings, refer to [Displays or sets the Gain0_0 and Gain0_1 outputs](#) and to [Displays or sets the Gain1_0 and Gain1_1 outputs](#). The settings must conform to a specified truth table as provided in the Seapoint Turbidity Meter or Chlorophyll Fluorometer user manual.

To calibrate an external sensor:

1. Connect the CTD-N to your computer.
2. Choose Start > All Programs > RD Instruments > CTDPro.

CTDPro starts and the CTDPro Main window opens.

3. Choose Sensors > Calibrate.

The Calibrate Sensor dialog box shown in Figure 54 opens.

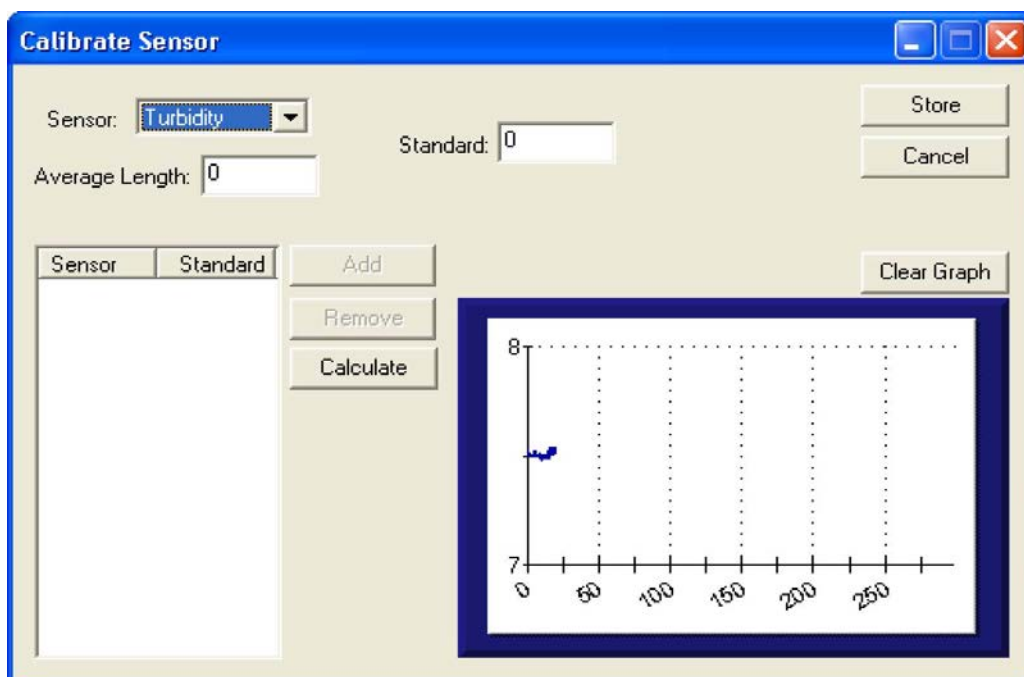

Figure 54. The Calibrate Sensor Dialog Box—Selecting the Sensor

4. In the Calibrate Sensor dialog box, select the sensor from the Sensor drop-down list box.

5. Set up a low point standard for the sensor. For example, if calibrating a turbidity sensor, cover the turbidity sensor's optical window with black electrical tape to block out all light entering the sensor.
6. Enter 0 in the Standard text box.



NOTE. You have to enter "0" even if "0" is already displayed. Entering 0 again enables the Add button.

7. Click Add.

The sensor is added along with the entered standard to the table as shown in Figure 55. A corresponding graph is also displayed.



NOTE. If an error is made, click Remove and repeat Steps 6 and 7. Allow the data to stabilize before clicking Add.

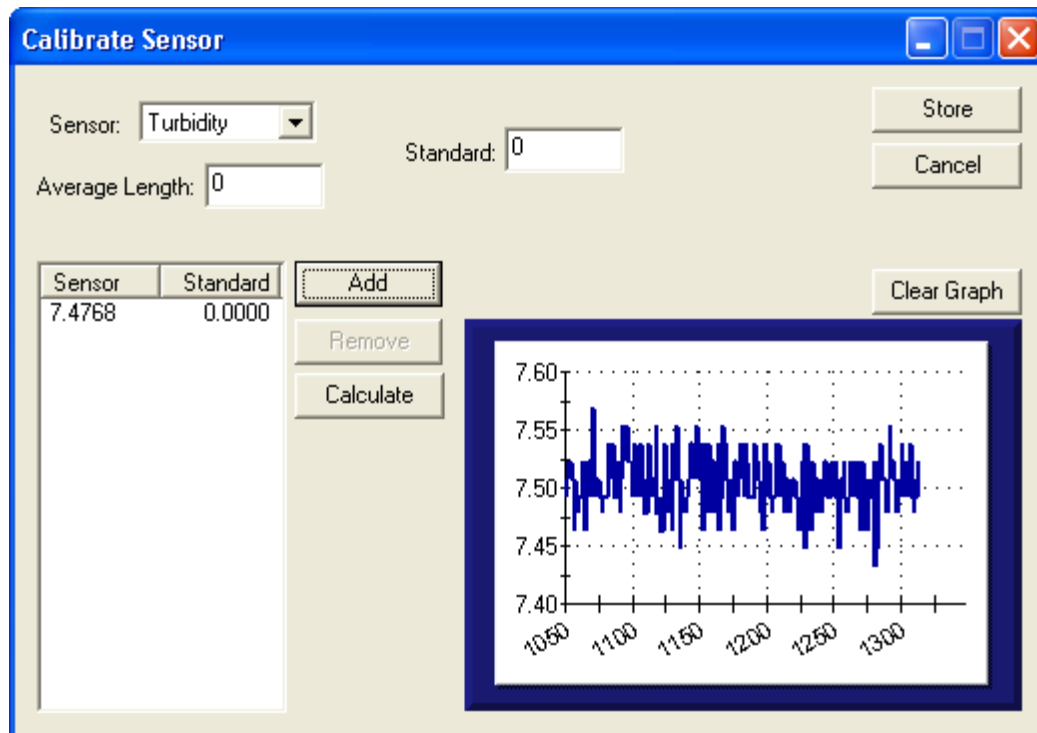

Figure 55. The Calibrate Sensor Dialog Box—Setting the Low

8. Set up a high point standard for the sensor. For example, if calibrating a turbidity sensor, expose the sensor to a liquid of known high clarity.
9. Enter the high point standard in the Standard text box. For example, the standard might be 200 for a turbidity sensor.
10. Click Add.

The second standard is added to the table.

11. If required, repeat the setup and standard entries for as many additional standards as desired in between the high and low standards.

The standards are added to the table and the graph as shown in Figure 56.

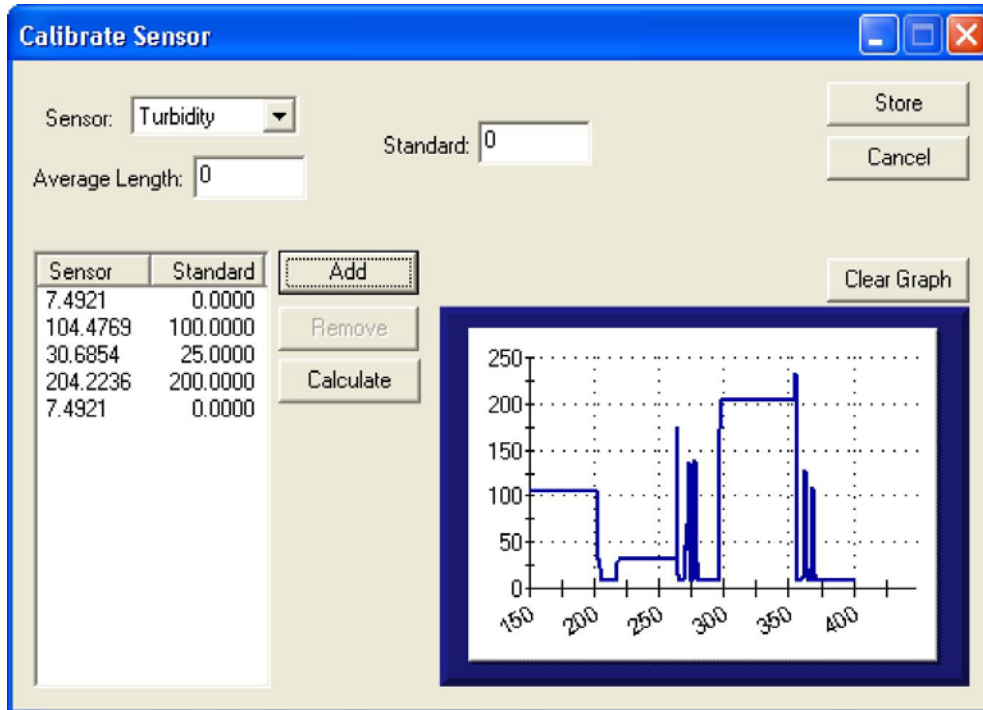

Figure 56. The Calibrate Sensor Dialog Box—Setting Additional Standard Points Including the High Point Standard

12. Click Calculate.

The Calibration Results window opens as shown in Figure 57 displaying the calibration equation coefficients.

13. Click Store to write the calibration coefficients to the CTD-N.

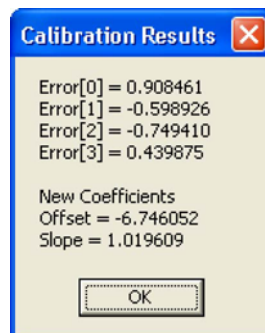

Figure 57. The Calibration Results Window

APPENDIX D:

CTD-N Commands

The Citadel CTD System can be connected to a PC using an RS-232 or RS-485 Cable (see [Installing CTDPro and Selecting the CTD-N](#) and [Connecting the CTD-N to Your Computer](#)). Commands are sent to the system through a terminal window (such as TRDI's *BBTalk* or CTDPro's terminal window). The CTD-N commands are listed in Table 16.

CTD-N Operating Modes

The CTD-N always runs in one of three operating modes. Each command applies specifically to one or more of these modes. The CTD-N can be placed into any operating mode by entering the appropriate command. The CTD-N operating modes are the following:

Run mode is the normal operating mode in which data are acquired and stored. There are three Run modes: Continuous, where data are acquired continuously; Interval, where data are acquired at specified intervals for specified periods; and Delayed Start, where data acquisition begins at a specified time and date in the future in Continuous or Interval mode. The instrument normally powers up in Run mode.

Open mode is used to update calibration and other operational parameters. While the instrument is in the OPEN mode all data collection functions are stopped. In this mode the user can access all instrument configurations such as calibration constants and parameter output/stored selections. All data requests in the OPEN mode will be responded to with an "OPEN MODE" response.

Calibration mode provides certain functions that are used when the instrument is calibrated.

Command Properties

All the CTD-N commands exhibit the following common properties:

- A command is executed only after a carriage return <CR> or a line feed <LF> character is received.
- Additional characters received after a <CR> or <LF> character are ignored until the command is executed.
- Unless specified otherwise, a command can be entered in either upper or lower case letters.
- All displays are followed by a <CR> and a <LF> character at the end of each line.
- A command is invalid if it is not recognized for the specific operating mode or if it is entered incorrectly or incompletely.
- If an entered command is invalid, the message "BAD COMMAND, TYPE ?+Enter" is displayed. Typing "?," and then pressing Enter, lists some common commands and their descriptions.

Entering Commands

To enter a CTD-N command:

1. Choose Start > All Programs > RD Instruments > CTDPro.

CTDPro starts and the CTDPro Main window opens.

2. Choose View > Terminal.

The Terminal window shown in Figure 58 opens.



Figure 58. The Terminal Window

3. Click anywhere in the Terminal window.
4. Type the command in accordance with the commands listed in Table 16.

For commands that do not set a firmware setting, simply type the command name followed by the enter key:

Input:

```
VER
```

Output:

```
VER  
Firmware Version 4.61
```

In this example, the VER command is entered, and the firmware version number is output.

For commands that do set firmware settings, typing the command name followed by the enter key displays the current setting:

Input:

```
CH0
```

Output:

```
CH0=ON
```

In this example, by typing CHO followed by the enter key, the system lets the user know that the Time channel is turned off. In order to change the value of a setting, enter the command name followed by an equal sign and then the value.

If you would like to save the current system configuration send the “***E” command. The system will save the settings to EEPROM. If power is cycled, the previously saved settings will be restored.

Table 16: CTD-N Commands

COMMAND	OPERATING MODE			FUNCTION
	R	O	C	
START	–	●	–	Starts data acquisition
***R	–	●	–	Go to the Run operating mode
***O	●	–	●	Go to the Open operating mode
***C	–	●	–	Go to the Calibration operating mode
***I	–	●	–	Go to Interval mode
***D	–	●	–	Go to Delayed Start mode
***E	–	●	–	Save the EE data base
CDATE	–	●	–	Displays and sets the calibration date
SRATE	●	●	●	Displays and sets the instrument sampling rate
DTIME	–	●	–	Displays and sets the delayed start time
DDATE	–	●	–	Displays and sets the delayed start date
ITIME	–	●	–	Displays and sets the interval time
OTIME	–	●	–	Displays and sets the on time
RCAL	–	●	–	Displays the calibration constants
SCKO	–	●	–	Enables checksum operation
CCKO	–	●	–	Disables checksum operation
RCKO	–	●	–	Displays the checksum setting
SSOT	–	●	–	Enables scaled output mode
CSOT	–	●	–	Disables scaled output mode
RSOT	–	●	–	Displays the scaled output setting
SCOP	–	●	–	Enables continuous on power up
CCOP	–	●	–	Disables continuous on power up
RCOP	–	●	–	Displays the continuous on power up setting

Table 16: CTD-N Commands

COMMAND	OPERATING MODE			FUNCTION
	R	O	C	
SB	–	●	–	Sets the baud rate
MODE	●	●	●	Displays the current mode
SAOP	–	●	–	Sets the address operation
CAOP	–	●	–	Clears the address operation
RAOP	–	●	–	Displays the address operation setting
TIME	–	●	–	Displays and sets the RTC time
DATE	–	●	–	Displays and sets the RTC date
DIAG	–	●	–	Runs diagnostics
ZMEM	–	●	–	Erases the entire flash memory
FDMP	–	●	–	Dumps a file in ASCII
AVGI	–	●	–	Sets the averaging interval
CHKF	–	●	–	Checks the flash memory
DDMP	–	●	–	Outputs scans from memory in ASCII
BDMP	–	●	–	Outputs scans from memory in binary
DLEN	–	●	–	Sets the number of scans to output
LOG	–	●	–	Sets the position of the logging pointer
S/N	–	●	–	Displays the serial number
ROP	●	●	●	Displays the current operational settings
VER	–	●	–	Displays the firmware version number
WHO	●	●	●	Displays the device name
ADR	–	●	–	Displays or sets the instrument address
RDM	●	●	●	Displays the channel names
DIR	●	●	●	Displays the file directory
C	●	●	●	Displays the current mode
?	●	●	●	Displays the Help menu
S	●	–	●	Closes the current file
SC	●	–	●	Sets continuous output

Table 16: CTD-N Commands

COMMAND	OPERATING MODE			FUNCTION
	R	O	C	
SFRM	–	●	–	Closes the current file
GAIN0	–	●	–	Displays or sets the Gain0_0 and Gain0_1 outputs
GAIN1	–	●	–	Displays or sets the Gain1_0 and Gain1_1 outputs

START

Starts data acquisition

Usage

START <filename> <CR> or <LF>

Operating Modes

Open

Description

The START command creates a file in the instrument and immediately begins acquiring and saving data to the file. Data are recorded at the sample rate set by the SRATE command.

Returns

<CR><LF>

Entering a <CR> or <LF> character a second time and every time thereafter displays a scan of data followed by a <CR><LF>.

See Also

S, SC, SRATE

Go to the Run operating mode**Usage**

***R <CR> or <LF>

Operating Modes

Open

Description

The ***R command sets the instrument into the Run operating mode. In Run mode the instrument acquires data in Continuous, Interval or Delayed Start mode. Data are recorded at the sample rate set by the SRATE command.

In Continuous mode, data are acquired continuously.

For the instrument to acquire data in Interval mode, valid interval and on times must have been entered. In Interval mode the instrument turns on and data are acquired at the beginning of each interval time as set by the ITIME command for the on time as set by the OTIME command. The instrument turns off at the end of each on time.

For the instrument to acquire data in Delayed Start mode, a valid delayed start time and date must have been entered. In Delayed Start mode data are acquired in either Continuous or Interval mode commencing at the time specified by the DTIME command and the date specified by the DDATE command.

Returns

<CR><LF>

Entering a <CR> or <LF> character a second time and every time thereafter displays a scan of data followed by a <CR><LF>.

See Also

ITIME, OTIME, DTIME, DDATE, S, SC, SRATE

Go to the Open operating mode

Usage

***O <CR> or <LF>

Operating Modes

Run, Calibration

Description

The ***O command sets the instrument into the Open operating mode. In Open mode data are not acquired and operational settings and calibration constants can be displayed and edited.

Returns

<CR><LF>

Entering a <CR> or <LF> character a second time and every time thereafter displays the following:

Open Mode



Go to the Calibration operating mode

Usage

***C <CR> or <LF>

Operating Modes

Open

Description

The ***C command sets the instrument into the Calibration operating mode. In Calibration mode reference data and raw data can be displayed.

Returns

<CR><LF>

Entering a <CR> or <LF> character a second time and every time thereafter displays a scan of data followed by a <CR><LF>.

See Also

S, SC

Go to Interval mode**Usage**

***I <filename> <CR> or <LF>

Operating Modes

Open

Description

The ***I command creates a file in the instrument and sets the instrument into the Interval operating mode of the Run mode if valid interval and on times have been entered. In Interval mode the instrument turns on and acquires and saves data to the file at the beginning of each interval time as set by the ITIME command for the on time as set by the OTIME command. Data are recorded at the sample rate set by the SRATE command. The instrument turns off at the end of each on time.

Returns

<CR><LF> Time = 10:51:41.54 Date = 08-12-2005 This ON Time Ends 11:11:40 08-12-2005 The NEXT Interval Starts 11:51:40 08-12-2005

Entering a <CR> or <LF> character a second time and every time thereafter displays a scan of data during the on time only followed by a <CR><LF>.

See Also

ITIME, OTIME, S, SC, SRATE

Go to Delayed Start mode**Usage**

***D <filename> <CR> or <LF>

Operating Modes

Open

Description

The ***D command creates a file in the instrument and sets the instrument into the Delayed Start mode of the Run operating mode if a valid delayed start time and date have been entered. In Delayed Start mode the instrument turns on and acquires and saves data to the file in the Continuous or Interval mode of the Run operating mode beginning at the time specified by the DTIME command and date specified by the DDATE command. Data are recorded at the sample rate set by the SRATE command.

In Continuous mode, data are acquired continuously.

For the instrument to acquire data in Interval mode, valid interval and on times must have been entered. In Interval mode data are acquired at the beginning of each interval time as set by the ITIME command for the on time as set by the OTIME command. The instrument turns off at the end of each on time.

Returns

<CR><LF>

Time = 11:22:54 Date = 08-12-2005 Normal Run Starts Delayed Start Ops Active

11:25:00 08-12-2005 bye_bye

See Also

DTIME, DDATE, ITIME, OTIME, SRATE

Save the EE data base

Usage

***E <CR> or <LF>

Operating Modes

Open

Description

The ***E command causes all calibration constants and operational settings to be written to flash memory.



CAUTION. The ***E command overwrites the current calibration constants and operational settings in flash memory. Before using the ***E command, use the RCAL command to verify that the calibration constants are correct.

Returns

<CR><LF>

See Also

RCAL

CDATE**Displays and sets the calibration date****Usage**

CDATE <CR> or <LF> CDATE=ddmmyy <CR> or <LF>

Operating Modes

Open

Description

The CDATE command displays and allows you to set the calibration date of the instrument.

When setting the calibration date, use the ddmmyy date format:

dd:	Day—01 to 31
mmm:	Month—JAN, FEB, MAR, APR, MAY, JUN, JUL, AUG, SEP, OCT, NOV, and DEC. Capital letters only.
yy:	Year—00 to 99 for 2000 to 2099

Returns

See examples below.

Examples

Enter CDATE <CR> or <LF> The instrument displays the current date:

CDATE=12AUG05 <CR><LF>

Enter CDATE=30AUG05 <CR> or <LF> The instrument sets the new date to August 30, 2005 followed by a <CR><LF>.

SRATE**Displays and sets the instrument sampling rate****Usage**

SRATE <CR> or <LF> SRATE=nn <CR> or <LF>

Operating Modes

Run, Open, Calibration

Description

The SRATE command displays and allows you to set the sampling rate of the instrument in Hz. The range of sampling rates is from 1 to 15 Hz.

The nn format is 1 to 15 for 1 to 15 Hz.



NOTE. Entering a number higher than 15 will be saved as 15.

Returns

See examples below.

Examples

Enter SRATE <CR> or <LF> The instrument displays the current instrument sampling rate:

SRATE=4 Hz <CR><LF>

Enter SRATE=8 <CR> or <LF> The instrument sets the new instrument sampling rate followed by a <CR><LF>.

DTIME**Displays and sets the delayed start time****Usage**

DTIME <CR> or <LF>

Operating Modes

Open

Description

The DTIME command displays and allows you to set the delayed start time of the instrument.



NOTE. The time set by the DTIME command must be later than the current time and date by at least one minute.

When setting the delayed start time, use the hh:mm:ss format:

hh:	Hours—01 to 24
mm:	Minutes—00 to 59
ss:	Seconds—00 to 59

Returns

See Examples below.

Examples

Enter DTIME <CR> or <LF>

The instrument displays the current delayed start time and allows you to enter a new time:

Delayed Start Time = 11:25:00

Enter time [hh:mm:ss]:

Enter a <CR><LF> to leave the delayed start time as is, or enter the time in hours, minutes and seconds, and then enter a <CR><LF>.

See Also

DDATE, TIME, DATE

Displays and sets the delayed start date**Usage**

DDATE <CR> or <LF>

Operating Modes

Open

Description

The DDATE command displays and allows you to set the delayed start date of the instrument.

When setting the delayed start date, use the mm-dd-yy format:

mm:	Month—01 to 12
dd:	Day—01 to 31
yy:	Year—00 to 99

Returns

See Examples below.

Examples

Enter DDATE <CR> or <LF>

The instrument displays the current delayed start date and allows you to enter a new date:

Delayed Start Date = 09-12-2005

Enter date (mm-dd-yy):

Enter a <CR><LF> to leave the delayed start date as is, or enter the date in days, months and years, and then enter a <CR><LF>.

See Also

DTIME, TIME, DATE

ITIME**Displays and sets the interval time****Usage**

ITIME <CR> or <LF>

Operating Modes

Open

Description

The ITIME command displays and allows you to set the interval time of the instrument. The interval time is the time in hours, minutes and seconds between the start of each on time.



NOTE. The time set by the ITIME command must be longer than the time set by the OTIME command by at least five seconds.

When setting the interval time, use the hh:mm:ss format:

hh:	Hours—01 to 24
mm:	Minutes—00 to 59
ss:	Seconds—00 to 59

Returns

If no interval time has been set:

NO Interval time Enter time (hh:mm:ss):

If an interval time has been set:

Interval Time = 01:00:00 Enter time (hh:mm:ss):

Examples

Enter ITIME <CR> or <LF>

The instrument displays the current interval time and allows you to enter a new time:

Interval Time = 01:00:00 Enter time [hh:mm:ss]:

Enter a <CR><LF> to leave the interval time as is, or enter the time in hours, minutes and seconds, and then enter a <CR><LF>.

See Also

OTIME, TIME, DATE

Displays and sets the on time

Usage

OTIME <CR> or <LF>

Operating Modes

Open

Description

The OTIME command displays and allows you to set the on time of the instrument. The on time is the time in hours, minutes and seconds beginning at the start of each interval time during which the instrument is on and collecting data.



NOTE. The time set by the OTIME command must be shorter than the time set by the ITIME command by at least five seconds.

When setting the on time, use the hh:mm:ss format:

hh:	Hours—01 to 24
mm:	Minutes—00 to 59
ss:	Seconds—00 to 59

Returns

If no on time has been set:

NO ON time Enter time (hh:mm:ss):

If an on time has been set:

ON Time = 00:00:20 Enter time (hh:mm:ss):

Examples

Enter OTIME <CR> or <LF>

The instrument displays the current on time and allows you to enter a new time:

ON Time = 00:00:20 Enter time [hh:mm:ss]:

Enter a <CR><LF> to leave the on time as is, or enter the time in hours, minutes and seconds, and then enter a <CR><LF>.

See Also

ITIME, TIME, DATE

RCAL**Displays the calibration constants****Usage**

RCAL <CR> or <LF>

Operating Modes

Open

Description

The RCAL command displays all of the instrument calibration constants.



NOTE. The ***E command must be entered to save any changed calibration constants. In addition, the instrument serial number and the version number of the firmware cannot be changed.

Returns

See Examples below.

Examples

Enter RCAL <CR> or <LF> The instrument displays the calibration constants:

S/N=1001 Firmware Version 2.2 CDATE=Not Set A1=0.0 B1=9.000000E-05 C1=0.0 D1=0.0
KFAC=1.360000 A2=0.0 B2=5.000000E-01 C2=0.0 D2=0.0 E2=0.0 F2=0.0

G2=0.0 H2=0.0 I2=0.0 A03=0.0 B03=0.0 C03=0.0 A503=1034.000000 B503=0.0 C503=0.0
A1003=2068.000000 B1003=0.0 C1003=0.0 A3=0.0 PS0=1.000000E-01 PS50=1034.400024
PS100=2068.800049

See Also

***C, ***E

CCKO, RCKO, SCKO

Sets, clears, or reads checksum operation

Usage

CCKO
RCKO
SCKO

Mode

OPEN

Description

These commands set, clear, or read the Checksum data output mode. Checksum data output mode adds the checksum at the end of the line of data in RUN mode. The SCKO command sets the Checksum mode. The CCKO command clears the Checksum mode. The RCKO command reads the state of the Checksum mode.



NOTE. A “***E” command must be issued after either command for changes to take effect upon next power up.

Returns

The state of the Checksum data output mode

Example

1. SCKO<CR><LF>
Checksum output set <CR><LF>
***E<CR><LF>
2. CCKO<CR><LF>
Checksum output cleared <CR><LF>
3. RSOT <CR><LF>
Checksum output set <CR><LF>
-OR-
Checksum output cleared <CR><LF>

CSOT, RSOT, SSOT

Sets, clears, and reads scaled output mode

Usage

CSOT
RSOT
SSOT

Operating Modes

Open

Description

These commands set, clear, and read the Scaled units mode. The SSOT command enables the scaled output of the data over a range of 0 to 65535 counts. The CSOT command sets the data format to be reported in engineering units. The RSOT command returns the state of the output, either on or off.



NOTE. A "***E" command needs to be issued after either one of these commands for changes to have an effect on next power up.

Returns

The state of the Scale units in run mode

Example

1. SSOT<CR><LF>
Scaled output set <CR><LF>
***E<CR><LF>
2. CSOT<CR><LF>
Scaled output cleared <CR><LF>
3. RSOT <CR><LF>
Scaled output set <CR><LF>
-OR-
Scaled output cleared <CR><LF>

See Also

***E

CCOP, RCOP, SCOP

Sets, clears, and reads continuous on power up

Usage

CCOP
RCOP
SCOP

Operating Modes

Open

Description

These commands set, clear, and read continuous data output after power up. The SCOP command enables continuous output of data immediately after power up. Data are output at the instrument sampling rate as set by the SRATE command and the baud rate as set by the SB command. The CCOP command clears the continuous data on power up. RCOP reads the state of continuous data.



NOTE. A “***E” command must be issued after either command for changes to take effect upon next power up.

Returns

The state of continuous data output on power up.

Example

1. SCOP<CR><LF>
Continuous set<CR><LF>
***E<CR><LF>
2. CCOP<CR><LF>
Continuous cleared<CR><LF>
***E<CR><LF>
3. RCOP<CR><LF>
Continuous set<CR><LF>
-OR-
Continuous cleared<CR><LF>

See Also

***E, SRATE, SB

SB**Sets the baud rate****Usage**

SBnn <CR> or <LF>

Operating Modes

Open

Description

The SB command sets and displays the baud rate of the instrument.



NOTE. The SB command must be followed by the ***E command to save the setting.



WARNING. If you change the baud rate of the instrument, you will not be able to communicate with the instrument until you set the baud rate of your computer to the same.

When setting the baud rate, use the nn format as follows:

15: Sets the baud rate to 115000

57: Sets the baud rate to 57600

38: Sets the baud rate to 38400

19: Sets the baud rate to 19200

96: Sets the baud rate to 9600

12: Sets the baud rate to 1200

30: Sets the baud rate to 300

Returns

See Examples below.

Examples

Enter SB19 <CR> or <LF> The instrument sets and displays the baud rate setting:

Unit now communicates at 19200 baud

See Also

***E

MODE

Displays the current mode

Usage

MODE <CR> or <LF>

Operating Modes

Run, Open, Calibration

Description

The MODE command displays the current operating mode of the instrument.

Returns

If the instrument is in Open mode:

Open Mode

If the instrument is in Run mode:

Run Mode

If the instrument is in Calibration mode:

Cal Mode

See Also

***R, ***O, ***C

CAOP, RAOP, SAOP, #N

Set, clear, or read address operation

Usage

CAOP
RAOP
SAOP
#Nxy

Mode

OPEN, RUN

ADR/CAOP/RAOP/SAOP commands only work in OPEN mode.

The #n/#N command can be entered in RUN or OPEN mode.

Continuous Output Mode (SCOP) cannot be used while in address operation mode.

Address Operation mode works ONLY with output format 0 (SFRM=0).

- When you try to enable the address operation mode using the SAOP command, if the SFRM command is set to a different format “ERROR! INCORRECT FORMAT FOR ADDRESS MODE” will display.
- If you try to change the SFRM setting after the Address Operation is enabled, you’ll get the error “ERROR, ADDRESSING ACTIVE”.

Description

These commands set, clear, or read address operation. The intent of address operation is to enable the use of multiple instruments on the same serial connection. The address for each instrument must be unique and configured via the ADR command prior to connecting multiple instruments. Address operation will then enable a user to interact with a given instrument by sending the correct #Nxy string (where xy is the address number 0 to 99), executing commands, and then de-addressing the unit by sending a # character.



CAUTION. The #Nxy command is case sensitive and will behave slightly different depending on the mode.

While in **Run** Mode:

- No carriage return is needed after the # to “lock” or “de-address” the unit.
- After entering #Nxy or #nxy, the unit will immediately output a sample line. If you entered an uppercase “N”, the setting “sticks” and you can send additional commands or simply send another carriage return to get another sample.
- If you entered a lower-case “n”, the unit resumes ignoring commands. Entering #Nxy will make the unit respond to commands again.
- Addressing different instruments with the #Nxy command will automatically “de-address” all other connected instruments.

While in **Open** mode:

- Commands are not processed until a carriage return is sent. For example, the unit will not output the results of the ROP command if you enter #Nxy ROP. Therefore, you’ll need to enter a carriage return after the #Nxy command which makes the setting “take hold” and then send the ROP command next.
- The lowercase #nxy command doesn’t function in Open mode.

SAOP

The SAOP command enables address operation. Once address operation is enabled, an instrument will respond to commands until a # character is sent. After this time, the instrument will ignore all commands until the instrument receives the string #Nxy (where xy is the instrument's address as set by the ADR command). After the instrument receives a valid address, it will respond to commands until another # character is sent. For example, if ADR=05, use #N05.

Note: The SAOP command must be followed by the ***E command to save the setting.

CAOP

The CAOP command disables address operation.



CAUTION. The CTD-N unit must be addressed via the command #Nxy before address operation can be disabled via the CAOP command. Follow the example shown below for **Open** mode; otherwise if you send the CAOP command with more than one unit connected in the chain, all of the CTDs will be talking over each other on the serial communication line.

Note: The CAOP command must be followed by the ***E command to save the setting.

RAOP

The RAOP command reads the address operation.

Address op set, Adr = xy

Address op cleared, Adr = xy (where xy is the address number 0 to 99)

Returns

The state of the address mode

Examples

Using #nxy (where xy is the address number 0 to 99) while in **Run** mode will return a single sample without having to manually "de-address" the unit afterwards. For example, if you have several CTDs in a chain, while they're all running, you could just read each unit once by sending:

```
#n00
+0.3388, +21.8176, -0.0200, +00.1742, +1488.0041 (unit 00 returns this data)
#n01
+0.3388, +21.8178, -0.0201, +00.1743, +1488.0046 (unit 01 returns this data)
#n02
+0.3390, +21.8181, -0.0221, +00.1744, +1488.0057 (unit 02 returns this data)
...etc.
```

However, if you need to control/configure multiple units in **Open** mode, then you'll have to enter multiple commands (note you **MUST** use an uppercase "N"):

```
#N00 (address/unlock unit 00)
***O (change to open mode)
ROP (review configuration)
Etc. etc. to change something in the configuration
***R (to restart run mode)
# (to de-address the unit)
#N01 (address/unlock unit 01)
***O (change to open mode)
ROP (review configuration)
Etc. etc. to change something in the configuration
***R (to restart run mode)
# (to de-address the unit)
... And so on...
```

See Also

ADR, SFRM

TIME**Displays and sets the RTC time****Usage**

TIME <CR> or <LF>

Operating Modes

Open

Description

The TIME command displays and allows you to set the current time of the real time clock in the instrument.

When setting the current time, use the hh:mm:ss format:

hh:	Hours—01 to 24
mm:	Minutes—00 to 59
ss:	Seconds—00 to 59

Returns

Time = 18:00:15.80 Enter time (hh:mm:ss):

Examples

Enter TIME <CR> or <LF> The instrument displays the current time and allows you to enter a new time:

Time = 18:00:15.80 Enter time (hh:mm:ss):

Enter a <CR><LF> to leave the time as is, or enter the time in hours, minutes and seconds, and then enter a <CR><LF>.

See Also

DATE

Displays and sets the RTC date

Usage

DATE <CR> or <LF>

Operating Modes

Open

Description

The DATE command displays and allows you to set the current date of the real time clock in the instrument.

When setting the current date, use the mm-dd-yy format:

mm:	Month—01 to 12
dd:	Day—01 to 31
yy:	Year—00 to 99

Returns

Date = 08-12-2005 Enter date (mm-dd-yy):

Examples

Enter DATE <CR> or <LF> The instrument displays the current date and allows you to enter a new date:

Date = 08-12-2005 Enter date (mm-dd-yy):

Enter a <CR><LF> to leave the date as is, or enter the date in days, months and years, and then enter a <CR><LF>.

See Also

TIME

DIAG**Runs diagnostics****Usage**

DIAG <CR> or <LF>

Operating Modes

Open

Description

The DIAG command runs the instrument diagnostics and displays the results.

Returns

See Examples below.

Examples

Enter diag <CR> or <LF>

The instrument displays the diagnostics:

```
Running diagnostics...
EEPROM OK
Real-Time Clock: Passed
Marker Code = 236 (0xEC)
Device Code = 218 (0xDA)
Size Code = 21 (0x15)
Flash Status = 224 (0xE0)
Clearing block table...
Regulated Supply Voltage (6 V) = 10.29 VDC
4V Reference = 4.00 VDC
Battery = 3.25 VDC
```

Erases the entire flash memory

Usage

ZMEM <CR> or <LF>

Operating Modes

Open

Description

The ZMEM command erases all of the data stored in the flash memory of the instrument. The calibration constants are not erased. In addition, the memory pointers are reset after the data are erased.

Returns

See Examples below.

Examples

Enter ZMEM <CR> or <LF> The instrument asks if you want to erase the data:

Erase the File Table?

Entering a <CR><LF> erases the data:

Memory erased.<CR><LF>

See Also

BERA, DLEN, DDMP

FDMP**Dumps a file in ASCII****Usage**

FDMP <filename> <CR> or <LF>

Operating Modes

Open

Description

The FDMP command dumps a file in ASCII.

Returns

See Examples below.

Examples

Enter FDMP <filename> <CR> or <LF>.

The instrument dumps the file in ASCII:

```
Read sequence, please wait... File Type: Continuous Sampling Rate: 10Hz A/D Rate: 55Hz
Delayed Start 00:00:00 00-00-00 Averaging Interval Time = 00:00 Interval Time =
00:00:00 ON Time = 00:00:00 1123871932.255, +188.7436, -999.9000, +2303535.0000,
+00.0389, +1710583808.4294957295, 3.52 1123871932.255, +188.7436, -999.9000,
+2303535.0000, +00.0389, +1710583808.4294957295, 3.52 1123871932.255, +188.7436, -
999.9000, +2303535.0000, +00.0389, +1710583808.4294957295, 3.52 1123871932.255, -
+188.7436, -999.9000, +2303535.0000, +00.0389, +1710583808.4294957295, 3.52
1123871933.255, +188.7436, -999.9000, +2303535.0000, +00.0389, +1710583808.4294957295,
3.52
```

Sets the averaging interval**Usage**

AVGI <CR> or <LF>

Operating Modes

Open

Description

The AVGI command displays and allows you to set the averaging interval of the instrument. The averaging interval is the time during the Continuous or Interval mode of the Run Operating mode that data are averaged. In Interval mode data are averaged during the on time only.



NOTE. The time set by the AVGI command must be 5 seconds or longer. Enter 4 seconds or less for no averaging.

When setting the interval time, use the mm:ss format: **mm:** Minutes—00 to 59 **ss:** Seconds—00 to 59

Returns

See Examples below.

Examples

Enter AVGI <CR> or <LF>

The instrument displays the current averaging interval and allows you to enter a new interval:

Averaging Interval Time = 00:00 Enter interval (mm:ss):

Enter a <CR><LF> to leave the averaging interval as is, or enter the interval in minutes and seconds, and then enter a <CR><LF>.

See Also

DATE, TIME, ITIME, OTIME, DTIME

CHKF**Checks the flash memory****Usage**

CHKF <CR> or <LF>

Operating Modes

Open

Description

The CHKF command checks the flash memory.

Returns

See Examples below.

Examples

Enter CHKF <CF> or <LF>.

The instrument checks the flash memory and displays the results:

Marker Code = 236 (0xEC) Device Code = 218 (0xDA) Size Code = 21 (0x15) Flash Status = 224
(0xE0) Clearing block table... Checking Blocks... Invalid Block: 0, Address = 137216 Invalid Block: 2,
Address = 407552

Outputs scans from memory in ASCII

Usage

DDMP <CR> or <LF>

Operating Modes

Open

Description

The DDMP command outputs and displays scans of recorded data in ASCII. The number of scans output and displayed is specified by the DLEN command.



NOTE. To determine which parameters have been logged, and in which order they were logged, enter the RDM command. The RDM command displays the number of bytes per scan.

Returns

See Examples below.

Examples

Enter DDMP <CR> or <LF> The instrument outputs the number of scans specified by the DLEN command.

See Also

DLEN, BDMP, RDM, LOG

BDMP

Outputs scans from memory in binary

Usage

BDMP <CR> or <LF>

Operating Modes

Open

Description

The BDMP command outputs and displays scans of recorded data in binary. The number of scans output is specified by the DLEN command. The data are output in IEEE Standard 4-byte binary form.



NOTE. To determine which parameters have been logged, and in which order they were logged, enter the RDM command. The RDM command displays the number of bytes per scan.

Returns

See Examples below.

Examples

Enter BDMP <CR> or <LF>

The instrument outputs and displays the number of scans specified by the DLEN command.

See Also

DLEN, DDMP, RDM

DLEN

Sets the number of scans to output

Usage

DLEN=nnnn <CR> or <LF>

Operating Modes

Open

Description

The DLEN command sets the number of scans of recorded data to output and display when using the DDMP or BDMP command.

The nnnn format is 1 to 9999.

Returns

See Examples below.

Examples

Enter DLEN=1200 <CR> or <LF>

The instrument sets the number of scans of recorded data to output to 1200 followed by a <CR><LF>.

See Also

DLEN, DDMP, BDMP, RDM, LOG

LOG**Sets the position of the logging pointer****Usage**

LOG=nnnnn <CR> or <LF>

Operating Modes

Open

Description

The LOG command sets the value of the logging pointer. The value of the logging pointer is the location of the next byte in memory to be written to flash memory.

The nnnn format is 1 to 99999.

Returns

See Examples below.

Examples

Enter LOG=1400 <CR> or <LF>

The instrument sets the position of the logging pointer to 1400 followed by a <CR><LF>.

See Also

DLEN, DDMP, BDMP, RDM

Displays the serial number

Usage

S/N <CR> or <LF>

Operating Modes

Open

Description

The S/N command displays the serial number of the instrument.

Returns

See Examples below.

Examples

Enter S/N <CR> or <LF> The instrument displays its serial number:

S/N=1001

See Also

VER

ROP**Displays the current operational settings****Usage**

ROP <CR> or <LF>

Operating Modes

Run, Open, Calibration.

Description

The ROP command displays all the current calibration constants and operational settings for the instrument.

Returns

See Examples below.

Examples

Enter ROP <CR> or <LF>

The instrument displays all the current calibration constants and operational settings:

```
S/N=1001 Open Mode Continuous cleared Address op cleared scaled output cleared check-  
sum output cleared CH0(TIME)=ON CH1(COND)=ON CH2(TEMP)=ON CH3(PRES)=ON CH4(SALT)=ON  
CH5(SNDV)=ON CH6(BATT)=ON ARATE=7 SRATE=10 Hz N=1 Autologging OFF
```

Displays the firmware version number

Usage

VER <CR> or <LF>

Operating Modes

Open

Description

The VER command displays the version number of the firmware in the instrument.

Returns

See Examples below.

Examples

Enter VER <CR> or <LF> The instrument displays the version number of the firmware:

Firmware Version 2.2

See Also

S/N

WHO

Displays the device name

Usage

WHO <CR> or <LF>

Operating Modes

Run, Open, Calibration

Description

The WHO command displays the device name. The device is the connected instrument.

Returns

See Examples below.

Examples

Enter WHO <CF> or <LF> The instrument displays the device name:

CTD-N

Displays or sets the instrument address**Usage**

ADR <CR> or <LF> and ADR=xy <CR> or <LF>

Operating Modes

Open

Description

The ADR command displays or sets the address of the instrument.



NOTE. The ADR command must be followed by the ***E command to save the setting.

The xy format is 00 to 99.

Returns

See Examples below.

Examples

Enter ADR <CR> or <LF>

The instrument displays the address of the instrument:

ADR=05 <CR> or <LF>

Enter ADR=67 <CR> or <LF> The instrument sets its address to 67 and outputs a <CR><LF>.

See Also

SAOP, CAOP, RAOP, ROP

RDM**Displays the channel names****Usage**

RDM <CR> or <LF>

Operating Modes

Run, Open, Calibration

Description

The RDM command displays the on or off status of each of the six data channels. The six data channels are the following:

TIME:	Time
COND:	Conductivity
TEMP:	Temperature
PRES:	Pressure
SALT:	Salinity
SNDV:	Sound velocity
BATT:	Battery

Returns

See Examples below.

Examples

Enter RDM<CR>

The instrument displays the six channels and the on or off status of each:

```
CH0 ( TIME ) =ON  
CH1 ( COND ) =ON  
CH2 ( TEMP ) =ON  
CH3 ( PRES ) =ON  
CH4 ( SALT ) =ON  
CH5 ( SNDV ) =ON  
CH6 ( BATT ) =ON
```

DIR**Displays the file directory**

Usage

DIR <CR> or <LF>

Operating Modes

Run, Open, Calibration

Description

The DIR command displays the file directory on the instrument.

Returns

See Examples below.

Examples

Enter DIR <CR> <LF>

The instrument displays the file directory:

```
Number of files: 3 Name Start Time      End Time Start End Size CTD DATA01 08/14/5 15:37
08/14/5 15:37 0      6235 6235 CTD DATA02 08/14/5 15:38 08/14/5 15:38      6235 10411
4176 File: CTD DATA03 is currently open. CTD DATA03 08/14/5 15:38 08/14/5 15:38
10411 12847 2436 End of files.
```

C

Displays the current mode**Usage**

C <CR> or <LF>

Operating Modes

Run, Open, Calibration

Description

The C command displays the current operating mode of the instrument.

Returns

If the instrument is in Open mode:

Open Mode

If the instrument is in Run mode:

Run Mode

If the instrument is in Calibration mode:

Cal Mode

See Also

***R, ***O, ***C

CH

Usage

CHx=ON <CR> or CHx=OFF<CR>

Operating Modes

Open

Description

For each command, typing the command by itself reports status, or the channel can be enabled (if applicable) or disabled by typing CHx=ON or CHx=OFF. When the channel is disabled, its value is excluded from the output string.

CH0 – Time

CH1 – Conductivity

CH2 – Temperature

CH3 - Pressure

CH4 - Salinity

CH5 - Sound Velocity

CH6 - Battery voltage



NOTE. The CH command must be followed by the ***E command to save the setting.

Returns

See Examples below.

Examples

Input:

CH0

Output:

CH0=ON

In this example, by typing CH0 followed by the enter key, the system lets the user know that the Time channel is turned on. In order to change the value of the setting, enter the command name followed by an equal sign and then the value. To turn the Time channel off, enter CH0=OFF followed by the enter key.

See Also

***E

**Displays the Help menu****Usage**

? <CR> or <LF>

Operating Modes

Open

Description

The ? command displays a Help menu, which lists many of the available commands. For detailed information on how to use these and other commands, refer to the information provided in this section.

Returns

Help menu.

S

Closes the current file

Usage

S

Operating Modes

Run, Calibration

Description

The S command stops the output of data in the Continuous mode of the Run operating mode. No <CR> or <LF> character is required.



NOTE. The S command must be entered as an upper case character.

Returns

None.

See Also

SC

Sets continuous output**Usage**

SC <CR> or <LF>

Operating Modes

Run, Calibration

Description

The SC command sets the instrument into the Continuous mode of the Run operating mode. The instrument outputs the data as soon as it is available.

Returns

Data are displayed one scan at a time.

See Also

S

Select the output format

Usage

SFRM <CR> or <LF> SFRM=n <CR> or LF>

Operating Modes

Open

Description

The SFRM command allows you to select the output format of the data from a list of available formats, including standard TRDI format. The output selections are available for special customer requirements and can be customized in accordance with customer needs.



NOTE. The SFRM command must be followed by the ***E command to save the setting.

Returns

See Examples below.

Examples

Enter SFRM <CR> or <LF> The instrument displays the current output format:

```
SFMR=1: 000452 23.24 45.3 35.17 12.3
```

Enter SFRM=1 <CR> or <LF> The instrument sets the new output format followed by a <CF<LF>.

To enable the Valeport output format:

1. First put the instrument into open mode:
***O
2. Configure the CTD-N to output the Valeport string by sending:
SFRM=8
3. Then set the CTD-N to run mode and continuous output:
***R
SC

Format Specifications**SFRM=0**

```
04-01-16, 08:32:19, +0.3432, +22.1575, +0.0047, +00.1753, +1488.9935, +21.48
DATE, TIME, CC.CCCC, TT.TTTT, PPPP.PPPP, SS.SSSS, VVVV.VVVV, vv.vv
```

SFRM=1

```
000009 22.15 0.3 0.18 12.3
hhmmss TT.TT CC.CC SS.SS 12.3
```

SFRM=2

```
000045 22.14 0.3 0.18 N/A 0.00 12.3
hhmmss TT.TT CC.CC SS.SS N/A PP.PP 12.3
```

SFRM=3

```
0.343, 22.139, 0.0003, 0.1751, 1488.9410
```

CC.CCC, TT.TTT, PP.PPPP, SS.SSSS, VVVV.VVVV

SFRM=4

000255 22.14 0.3 0.18 12.3 00000 00000 00000 00000 0.0
 hhmmss TT.TT CC.CC SS.SS 12.3 optData0 optData1 optData2 optData3 BioSpherical

SFRM=5

000509 22.13 0.3 0.18 N/A -0.00 12.3 00000 00000 00000 00000 0.0
 hhmmss TT.TT CC.CC SS.SS N/A PP.PP 12.3 optData0 optData1 optData2 optData3 BioSpherical

SFRM=6

000721 22.13 0.3 0.18 21.52 0.0000 0.0000 0.0000 0.0000 0.000 0.000
 0.000
 hhmmss TT.TT CC.CC SS.SS vv.vv optData0 optData1 optData2 optData3 Compass Pitch Roll

SFRM=7

\$BFCTD,+0.1525,22.1323,+0.0046,10:26:44 04-01-16,+03.0161,+1492.7867,*66
 SBFCTD, CC.CCCC, TT.TTTT, PP.PPPP, hh:mm:ss mm-dd-yy, SS.SSSSS, VVVV.VVVV, *ck

SFRM=8

+VVV.VVVV \t M/SEC \t +PP.PPPP \t DBAR \t +TT.TTTT \t C \t +CC.CCCC \t MS/CM \t
 +SS.SSSS \t PSU\r\n

Where:

- VVVV.VVVV = Sound Velocity
- PP.PPPP = Pressure
- TT.TTTT = Temperature
- CC.CCCC = Conductivity
- SS.SSSS = Salinity
- \t = tab (0x09 binary, 8-bits)
- \r = return (0x0d binary, 8-bits)
- \n = line feed (0x0A binary, 8-bits)

Sample Output

```

***O
SFRM=8
***R
SC
+1492.7867 M/SEC +0.0046 DBAR +23.5327 C +0.1525 MS/CM +00.0774 PSU
+1492.7819 M/SEC +0.0144 DBAR +23.5310 C +0.1524 MS/CM +00.0773 PSU
+1492.7777 M/SEC +0.0236 DBAR +23.5294 C +0.1524 MS/CM +00.0773 PSU
+1492.7734 M/SEC +0.0309 DBAR +23.5278 C +0.1523 MS/CM +00.0773 PSU
+1492.7706 M/SEC +0.0237 DBAR +23.5268 C +0.1525 MS/CM +00.0774 PSU
+1492.7650 M/SEC +0.0194 DBAR +23.5249 C +0.1522 MS/CM +00.0773 PSU
S
    
```

See Also

***E, CAOP, RAOP, SAOP, Figure 15, page 27

GAIN0

Displays or sets the Gain0_0 and Gain0_1 outputs

Usage

GAIN0 <CR> or <LF> and GAIN0=n <CR> or <LF>

Operating Modes

Open

Description

The GAIN0 command displays or sets the Gain0_0 and Gain0_1 outputs. These are logic outputs on the Option 1 connector; they correspond to Gain Control A and Gain Control B, respectively, for Channel 1 as shown in Table 12.



NOTE. The Gain0_0 and Gain0_1 outputs should be connected to +5 VDC through a 10-Kohm resistor for standard TTL logic.



NOTE. The Gain0_0 and Gain0_1 outputs are set only after the instrument is set into either the Run or the Calibration operating mode.

There are four possible output setting combinations for Gain0_0 and Gain0_1 where an ON setting corresponds to an output of 0 volts and an OFF setting to an output of +5 VDC:

Gain0=0: Gain0_0 = OFF, Gain0_1 = OFF **Gain0=1:** Gain0_0 = ON, Gain0_1 = OFF **Gain0=2:** Gain0_0 = OFF, Gain0_1 = ON **Gain0=3:** Gain0_0 = ON, Gain0_1 = ON



NOTE. The GAIN0 command must be followed by the ***E command to save the setting.

Returns

See Examples below.

Examples

Enter GAIN0 <CR> or <LF> The instrument displays the gain setting:

GAIN0 Gain0_0: ON Gain0_1: ON

Enter GAIN0=2 <CR> or <LF>

The instrument sets the Gain0_0 output to OFF (+5 VDC) and the Gain0_1 output to ON (0 volts) for Channel 1.

See Also

***E

GAIN1

Displays or sets the Gain1_0 and Gain1_1 outputs

Usage

GAIN1 <CR> or <LF> and GAIN1=n <CR> or <LF>

Operating Modes

Open

Description

The GAIN1 command displays or sets the Gain1_0 and Gain1_1 outputs. These are logic outputs on the Option 1 connector; they correspond to Gain Control A and Gain Control B, respectively, for Channel 2 as shown in Table 12.



NOTE. The Gain1_0 and Gain1_1 outputs should be connected to +5 VDC through a 10-Kohm resistor for standard TTL logic.



NOTE. The Gain1_0 and Gain1_1 outputs are set only after the instrument is set into either the Run or the Calibration operating mode.

There are four possible output setting combinations for Gain1_0 and Gain1_1 where an ON setting corresponds to an output of 0 volts and a OFF setting to an output of +5 VDC:

Gain1=0: Gain1_0 = OFF, Gain1_1 = OFF **Gain1=1:** Gain1_0 = ON, Gain1_1 = OFF **Gain1=2:** Gain1_0 = OFF, Gain1_1 = ON **Gain1=3:** Gain1_0 = ON, Gain1_1 = ON



NOTE. The GAIN1 command must be followed by the ***E command to save the setting.

Returns

See Examples below.

Examples

Enter GAIN1 <CR> or <LF> The instrument displays the gain setting:

GAIN1 Gain1_0: ON Gain1_1: ON

Enter GAIN1=2 <CR> or <LF>

The instrument sets the Gain1_0 output to OFF (+5 VDC) and the Gain1_1 output to ON (0 volts) for Channel 2.

See Also

***E

APPENDIX E: Warranty, Liability, and RMA Return Procedure

Teledyne RD Instruments Limited Warranty

Teledyne RD Instruments (TRDI) guarantees its products to be free from defects in materials and workmanship for a period of one year from the date of shipment. In the event a product malfunctions during this period, TRDI's obligation is limited to the repair or replacement, at TRDI's option, of any product returned to the TRDI factory. Products found defective should be returned to the factory freight prepaid and carefully packed, as the customer will be responsible for any damage during shipment.

Repairs or replacements, parts, labor, and return shipment under this warranty will be at no cost to the customer. This warranty is void if, in TRDI's opinion, the product has been damaged by accident or mishandled, altered, or repaired by the customer, where such treatment has affected its performance or reliability. In the event of such mishandling, all costs for repair and return freight will be charged to the customer. All products supplied by TRDI that are designed for use under hydrostatic loading have been certified by actual pressure testing prior to shipment. Any damage that occurs as a direct result of flooding is NOT covered by this warranty.

If a product is returned for warranty repair and no defect is found, the customer will be charged a diagnostic fee plus all shipping costs. Incidental or consequential damages or costs incurred as a result of a product's malfunction are not the responsibility of TRDI.

Equipment not manufactured by TRDI is supported only to the extent of the original equipment manufacturer's (OEM) original warranties. All OEM sensors that utilize electrodes (oxygen cartridges, pH, ORP, etc.) are warranted at the time of shipment, and shall perform upon initial installation within stated specifications. If the product proves to be defective within the OEM's warranty, TRDI will replace the product or defective part with a similar model, product or part, but only to the extent that the OEM warrants.

All returned products must be accompanied by a Returned Material Authorization (RMA) number issued by TRDI. Shipments without an RMA number will not be accepted.

Liability

TRDI shall not be liable for incidental or consequential damages, injuries, or losses as a result of the installation, testing, operation, or servicing of TRDI products.

Returning CTDs to TRDI for Service

When shipping the system to TRDI from either inside or outside the United States, the following instructions will help ensure the CTD arrives with the minimum possible delay. Any deviation from these instructions increases the potential for delay.

- All shipments must be accompanied by two copies of your commercial invoice showing value of material and any reason for return.
- Whenever possible, please send copies of the original export shipping documents with the consignment.
- If the equipment is property of TRDI, please insure for full value.
- If the value is in excess of \$1,000,000, the following shippers oath must be sent with the invoices. (This can be typed on the invoice or on a separate letterhead).

“I, _____, declare that the articles herein specified are, the growth, produce, or manufacture of the United States; that they were exported from the United States; from the Port of _____, on or about _____; that they are returned without having been advanced in value or improved in condition by any process of manufacture or any other means, that no drawback, bounty, or allowance has been paid or admitted thereof.

Signed _____”

Domestic Shipments

Step 1 - Request a Return Material Authorization

To obtain a Return Material Authorization (RMA) number and shipping instructions for the return of your instrument, do one of the following:

- Open the RMA using the web link: <http://adcp.com/support/sendADCP.aspx>
- Contact Customer Service Administration at rdicsadmin@teledyne.com
- Call +1 (858) 842-2700

When requesting a RMA number, please give us the following information:

- What is being shipped (include the serial number)
- When you plan to send the shipment
- What issue(s) need to be corrected
- Name of the Field Service Engineer that knows about the issue
- When you need the instrument returned

TRDI's Customer Service will then respond with the RMA number for the shipment. Please include this number on all packages and correspondence.

Step 2 – Provide a MSDS as necessary

Please provide a Material Safety Data Sheet (MSDS) if the system/transducer is painted with anti-fouling paint.

Step 3 - Ship via air freight, prepaid

Urgent Shipments should be shipped direct to TRDI via overnight or priority air services. Do not send urgent airfreight as part of a consolidated shipment. If you ship consolidated, it will cost less, but may lose up to three days in transit time.

Non-urgent shipments may be shipped as part of a consolidated cargo shipment to save money. In addition, some truck lines may offer equivalent delivery service at a lower cost, depending on the distance to San Diego.

Mark the Package(s)

**To: Teledyne RD Instruments, Inc. (RMA Number)
14020 Stowe Drive
Poway, California 92064**

**Airport of Destination = San Diego
Notify Paxton, Shreve, and Hayes
Phone: +1 (619) 232-8941
Fax: +1 (619) 232-8976**

Step 4 - Urgent shipments

Send the following information by fax or telephone to TRDI.

**Attention: Customer Service Administration
Fax: +1 (858) 842-2822
Phone: +1 (858) 842-2700**

- Detailed descriptions of what you are shipping (number of packages, sizes, weights, and contents).
- The name of the freight carrier
- Master Air bill number
- Carrier route and flight numbers for all flights the package will take

European Shipments

Step 1 - Request a Return Material Authorization

To obtain a Return Material Authorization (RMA) number and shipping instructions for the return of your instrument, do one of the following:

- Open the RMA using the web link: <http://adcp.com/support/sendADCP.aspx>
- Contact Customer Service Administration at rdiefs@teledyne.com
- Call +33(0) 492-110-930

When requesting a RMA number, please give us the following information.

- What is being shipped (include the serial number)
- When you plan to send the shipment
- What issue(s) need to be corrected
- Name of the Field Service Engineer that knows about the issue

- When you need the instrument returned

TRDI's Customer Service will then respond with the RMA number for the shipment. Please include this number on all packages and correspondence.

Step 2 – Provide a MSDS as necessary

Please provide a Material Safety Data Sheet (MSDS) if the system/transducer is painted with anti-fouling paint.

Step 3 - Ship Via Air Freight, Prepaid

Urgent Shipments should be shipped direct to TRDI via overnight or priority air services. Do not send urgent airfreight as part of a consolidated shipment. If you ship consolidated, it will cost less, but may lose up to three days in transit time.

Non-urgent shipments may be shipped as part of a consolidated cargo shipment to save money.

Mark the package(s) as follows:

**To: Teledyne RD Instruments, Inc. (RMA Number)
2A Les Nertieres
5 Avenue Hector Pintus
06610 La Gaude, France**

Step 4 - Include Proper Customs Documentation

The Customs statement must be completed. It should be accurate and truthfully contain the following information.

- Contents of the shipment
- Value
- Purpose of shipment (example: "American made goods returned for repair")
- Any discrepancy or inaccuracy in the Customs statement could cause the shipment to be delayed in Customs.

Step 4 - Send the Following Information by Fax or Telephone to TRDI

Attention: Sales Administration

Phone: +33(0) 492-110-930

Fax: +33(0) 492-110-931

- Detailed descriptions of what you are shipping (number of packages, sizes, weights, and contents).
- The name of the freight carrier
- Master Air bill number
- Carrier route and flight numbers for all flights the package will take

NOTES