

# PATHFINDER

## ROV

## INTEGRATION GUIDE



TELEDYNE  
MARINE  
Everywhereyoulook™

P/N 95B-6119-00 (July 2023)

© 2023 Teledyne RD Instruments, Inc. All rights reserved.



<https://www.teledynemarine.com>

Use and Disclosure of Data Information contained herein is classified as EAR99 under the U.S. Export Administration Regulations. Export, reexport or diversion contrary to U.S. law is prohibited.

## TABLE OF CONTENTS

GETTING STARTED WITH THE PATHFINDER .....	1
CONNECTING TO THE PATHFINDER.....	1
MECHANICAL INTEGRATION.....	7
ELECTRICAL INTEGRATION .....	10
ACOUSTIC INTEGRATION .....	11
OPERATIONAL & SETUP INTEGRATION.....	12
WANT TO KNOW MORE? .....	15

## HOW TO CONTACT TELEDYNE RD INSTRUMENTS

If you have technical issues or questions involving a specific application or deployment with your instrument, contact our Field Service group:

Teledyne RD Instruments	Teledyne RD Instruments Europe
14020 Stowe Drive Poway, California 92064	2A Les Nertieres 5 Avenue Hector Pintus 06610 La Gaude, France
Phone +1 (858) 842-2600	Phone +33(0) 492-110-930
Sales – <a href="mailto:rdisales@teledyne.com">rdisales@teledyne.com</a>	Sales – <a href="mailto:rdie@teledyne.com">rdie@teledyne.com</a>
Field Service – <a href="mailto:rdifs@teledyne.com">rdifs@teledyne.com</a>	Field Service – <a href="mailto:rdiefs@teledyne.com">rdiefs@teledyne.com</a>

Client Services Administration – [rdicsadmin@teledyne.com](mailto:rdicsadmin@teledyne.com)

Web: <https://www.teledynemarine.com>

For all your customer service needs including our emergency 24/7 technical support, call +1 (858) 842-2700

### Self-Service Customer Portal

Use our online customer portal at <https://www.teledynemarine.com/support/RDI/technical-manuals> to download manuals or other Teledyne RDI documentation.

### Teledyne Marine Software Portal

Teledyne RD Instruments Firmware, software, and Field Service Bulletins can be accessed only via our Teledyne Marine software portal.

To register, please go to <https://tm-portal.force.com/TMsoftwareportal> to set up your customer support account. After your account is approved, you will receive an e-mail with a link to set up your log in credentials to access the portal (this can take up to 24 hours).

Once you have secured an account, use the Teledyne Marine software portal to access this data with your unique username and password.

If you have an urgent need, please call our Technical Support hotline at +1-858-842-2700.

# Getting Started with the Pathfinder

## Identifying what's in the Box

### Pathfinder ROV Inventory

Part Number	Name	Description
70B-9042-xx	Pathfinder ROV version	The Pathfinder ROV 600 kHz system includes the transducer and connector protective cap. When unpacking, use care to prevent physical damage to the transducer face and connectors. Use a soft pad to protect the transducer.
97B-7010-00	ROV hard Shipping Case	Shipping case with foam inserts.
73B-6058-00	ROV PWR/COMM Pigtail Cable	The DVL PWR/COMM pigtail cable allows you to build custom cable to connect the Pathfinder to your vehicle/platform. It provides all the leads for serial and Ethernet COM, Power and Trigger.
95Z-6007-00 95B-6117-00 (part of 75BK6110-00)	Download instructions Pathfinder ROV Getting Started Guide	This sheet has instructions for downloading the software and manuals. A printed quick start card showing test setup is included.
ROV Spare Parts*	See table below for description	Anodes and closing hardware



This list only shows the part included with the standard ROV Pathfinder DVL. See the packing slip for additional options. If you are missing parts, contact TRDI support [rdifs@teledyne.com](mailto:rdifs@teledyne.com) or call +1 (858) 842-2700.

### Pathfinder ROV Spare Parts\*

Description	Part number	Where used
Anode, housing, top	81B-4146-00	Anodes for Housing Exterior
Anode, housing, bottom	810-4106-00	
Anode Screw	M5X0.8X10FH	
Anode Screw	M2.5X0.45X8FH	Closing hardware for housing
M4 Washer	M4WASHMOD	
M4 Split Washer	M4WASHSPL	
M4 Nylon Washer	M4WASHNYLON	
M4 Nut	M4X0.7NUT	
Isolator	91145A148	
M4 Bolt	M4X0.7X25SH	

## Installing Documentation and Software

The Pathfinder documentation and software are downloaded.

1. Follow the instruction sheet on downloading TRDI software and manuals.
2. Software is available on <https://tm-portal.force.com/TMsoftwareportal>. Install *TRDI Toolz* and *NavUI*.
3. Use our online customer portal at <https://www.teledynemarine.com/sup-portal/RDI/technical-manuals> to download manuals or other Teledyne RDI documentation. Download the Pathfinder Guide. PDF versions of all Pathfinder documentation are available for download.



# Connecting to the Pathfinder

## Power Overview

The Pathfinder requires a DC supply between 10.7 to 36 VDC (24 VDC typical). Either an external DC power supply or battery can provide this power. The power supply should be able to source at least two Amps for a bench test setup (no pinging).

**Power on Cycle** - The power supply must be able to handle the inrush current as well. Inrush current is the current required to fully charge up the capacitors when power is applied to the Pathfinder. The capacitors provide a store of energy for use during transmit. The inrush current is as much as four amps if plugged in after the DVL Transmit Cap is fully discharged. The Pathfinder will draw this amperage until its capacitors are fully charged (less than 200ms).



*If the power supply limits the current or the power drop on the cable is significant, then the power on cycle will fail or the system will reset during pinging. Therefore, TRDI recommends a 1.5 to 2 Amp power supply to cover all performance cases.*



*If the Power is put in then removed within a very short time (few secs) and then applied again, then the Inrush limiter will not be able to limit the current pulled from the DVL which would result in a higher than 4Amps Inrush current spike.*

## Wiring Diagrams

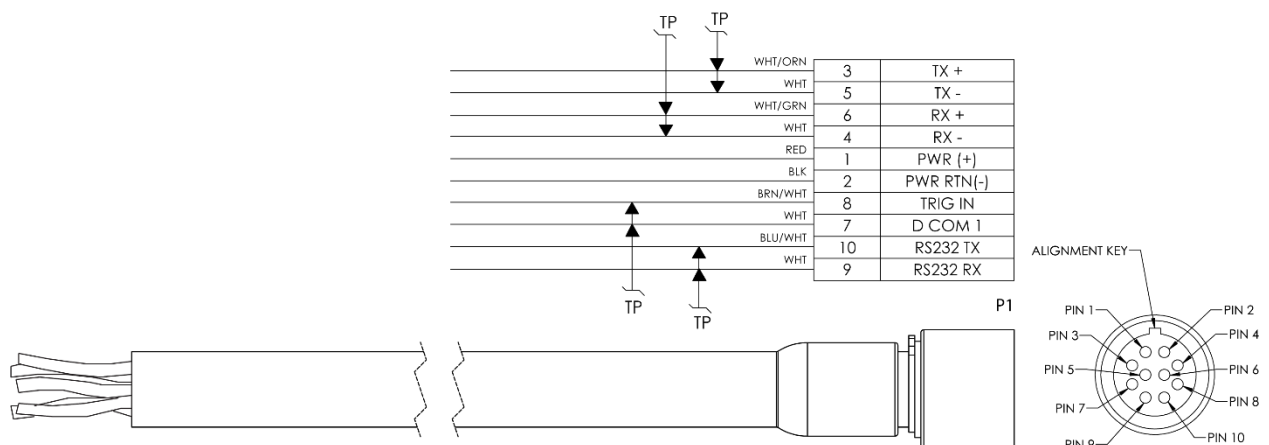

**Pathfinder ROV Power/Comm Cable 73B-6058 Pigtail Cable**



Where shown, RX is the incoming signal; TX is the outgoing signal.  
Cable bend radius is 4.5 inches. The connector part number is MKS(W)-3L10-CCP-SB from Teledyne Impulse.

# Using the Optional Test Cables



The optional Power/Comm Test cable and Power Adapter cable are included in the 75BK6086-00 ROV Integration Kit.

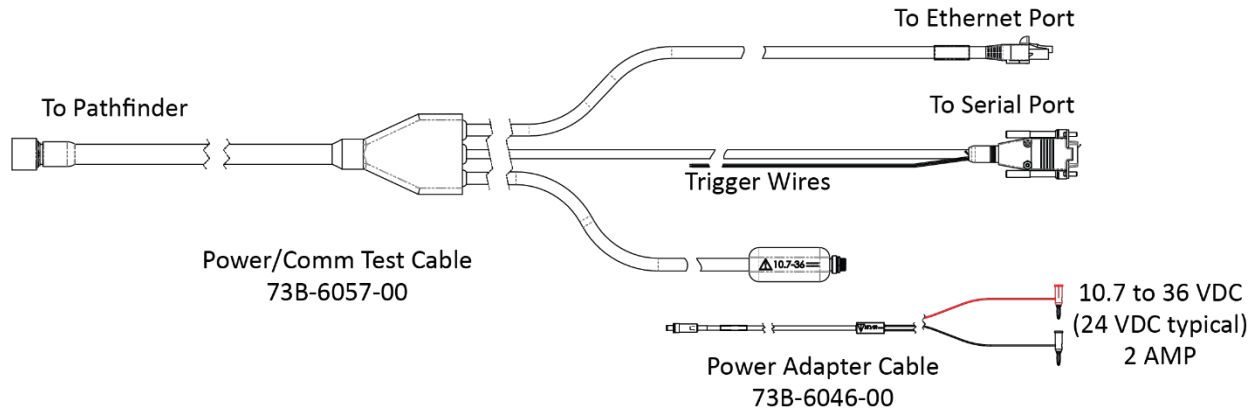

## ROV Pathfinder Connections for Bench Test [73B-6057-00 & 73B-6046-00 Cables]



The Optional Test Cable Kit 75BK6142-00 kit includes the 73B-6057-00 & 73B-6046-00 Cables and a USB adapter.

If you purchase your own USB adapter, TRDI recommends: [sales@connectiveperipherals.com](mailto:sales@connectiveperipherals.com)  
<https://us.connectiveperipherals.com/products/ft232r-chipset?variant=32248004476987>. Possibly any device with FTDI drivers and devices will also work.

## Installing the USB Adapter Driver

If there is an available internet connection, Windows 10/11 will install the USB driver on first connection. If necessary, install the Virtual COM port (VCP) driver to make the USB adapter appear as an additional COM port. The free FTDI driver download page is available here: <https://ftdichip.com/drivers/>

Use Windows Device Manager® to determine the USB to Serial adapter COM port number. Remove the adapter, wait a moment, note the list of ports, reinsert the adapter and note the new port.

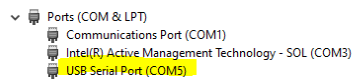

# Using TRDI Toolz

## To establish communications with the Pathfinder:

1. Connect the system and apply power.
2. Start *TRDI Toolz*.
3. Select **New Serial Connection** or **New Ethernet Connection**.



The command-and-control port can be Serial or Ethernet, but not both.

4. Enter the Pathfinder’s communication settings.

### Serial Communications:

Select the **COM Port** the serial cable is connected to and set the **Baud Rate** from the drop-down list to 115200

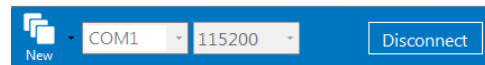

### Ethernet Communications:

Enter the Static DHCP server **IP or host name** 192.168.1.100  
 Enter the **Port Number** 1033  
 Select **TCP**



If the network assigns a Dynamic IP address, the Static IP address **192.168.1.100** will not work; Connect using the serial port and use the CE command to verify the IP address. You must have the RJ45 connector plugged into the network switch for the CE command to return the Ethernet setting info.

There is a 10 to 15 second delay after power is applied before the serial or Ethernet port is available.

5. Click the **Connect** button. Once connected, the button will change to **Disconnect** and the tab will show a green box.
6. Click the **Break** (⚡) button. The wakeup banner will be displayed in the Terminal window.

The screenshot shows the TRDI Toolz software interface. Callouts point to the following features:

- Communication session tabs:** Located at the top left of the interface.
- Ensemble Display Layout, Show Ensemble Display:** Points to the central data visualization area.
- Log to File:** A button located below the ensemble display.
- Terminal Display:** Points to the bottom section of the interface where text is displayed.
- Terminal Options:** A button located at the bottom left of the terminal area.
- Send BREAK:** A button located at the bottom center of the terminal area.
- Send single command:** A button located at the bottom right of the terminal area.
- Display Help file:** A button located in the top right corner of the interface.
- Use the Script Editor to send multiple commands to the ADCP Tools, Script Editor:** Points to the right-hand pane of the interface.

## Using the Network Configuration Page



The system must be connected to the Ethernet port to use the Network Configuration page.

### To establish communications with the Network Configuration page:

1. Connect the system and apply power.
2. Open a browser on the laptop (*Internet Explorer®*, *FireFox®*, *Google Chrome®*, or other browser).
3. Enter the Pathfinder's DHCP server IP address **192.168.1.100** into the address bar.
4. On **Network Configuration**, choose **STATIC** or **DHCP**. Use Dynamic Host Configuration Protocol (DHCP) server protocol when the network automatically provides an Internet Protocol (IP) host with its IP address and other related configuration information such as the subnet mask and default gateway.

If you are using a STATIC network, then configure the **Base IP Address**, **Network Mask**, **Gateway Address**, **Name Server Address**, and **Command/Control Port** as needed. The default configuration is shown below.

5. On the Output Formats section, enable or disable the output data formats (PD0, PD4, PD5, PD6, and PD13), **Protocol (TCP or UDP)**, **Address**, and **Ports**. Once done, click **Submit**.



If all outputs are enabled, it can affect the ping rate.

Phased Array DVL Network Configuration

Network Settings

Network Configuration: **STATIC** | Link Status: **Not Active**

Base IP Address: 10.20.229.10

Network Mask: 255.255.255.0

Gateway Address: 10.20.229.1

Name Server Address: 10.20.229.1

Command/Control Port: 1033

Output Formats

FORMAT	ENABLE	PROTOCOL	ADDRESS	PORT
PD0	ON	TCP	10.20.229.99	1036
PD4	ON	TCP	10.20.229.1	1036
PD5	ON	UDP	10.20.229.5	1037
PD6	ON	UDP	10.20.229.5	1038
PD11	ON	UDP	10.20.229.5	1039
PD13	ON	TCP	10.20.229.11	1040
PD26	ON	TCP	10.20.229.1	1041

Submit | Reset



Network Configuration Page

# Testing the Pathfinder DVL

## To test the Pathfinder:

1. Interconnect the system and apply power.
2. Place the Pathfinder transducer in water (at least a few inches to cover the transducer face).
3. Start the *TRDI Toolz* program and connect.
4. Click the **Break** (⚡) button. The wakeup banner appears on the Terminal window.

```
DVL
Teledyne RD Instruments (c) 2021
All rights reserved.
Firmware Version: 83.xx
Current time is: 21/12/22,09:01:38.47
Break received, serial
>
```

5. Enter the following commands in the command box:
  - Enter **CR1** then press the  icon. This will set the Pathfinder to the factory default.
  - Enter **CK** then press the  icon. This will save the factory default setting.
  - Enter **PA** then press the  icon. This will run the Pathfinder Pre-Deployment test.



Submerge the transducer face in a few inches of water. **The PA test may fail in air.** Only a failure with the transducer in water is a relevant test.



This test may fail if the Pathfinder is exposed to electrical interference such as that from other acoustic devices or SONARs or other electronic devices (i.e., cellphones, radios, computers, TV's, etc.).

```
>PA
ROM Test...PASS [ 3aad ]
RAM test...PASS
FRAM test...PASS
Receive Buffer Test...PASSED
XMIT RAM Test...PASSED
Receive Path Test (Hard Limited)...PASSED
Transmit/Receive Continuity Check...PASSED
Composite Result:
  GO for Deployment
```

6. If the wakeup banner displays and PA message displays with a result of “GO for Deployment”, the Pathfinder is functioning normally.

## LED Overview

The LED should be solid on if no data is moving over the serial port and there is no active TCP/IP connection on the Ethernet interface.

- The LED will blink 250ms/500ms when there is data on the serial port.
- The LED will blink 250ms/1000ms when there is traffic on the Ethernet port.

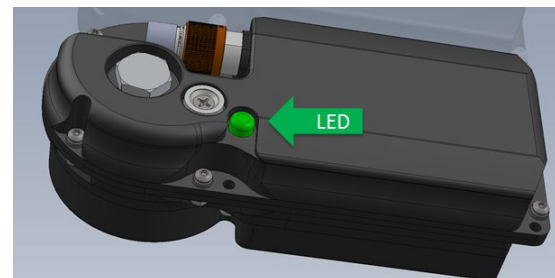



# Mechanical Integration

## Alignment

The mechanical alignment of the transducer head is important to DVL data accuracy. Mechanically mount the head as close as possible to your reference point. You also must mount the transducer head as level as possible using the ship's roll and pitch references.

 TRDI recommends mounting the transducer head with Beam 3 (instrument Y-axis) rotated 45° relative to the ship forward axis.

Mounting the transducer head with Beam 3 (instrument Y-axis) rotated 45° relative to the ship forward axis causes the magnitude of the signal in each beam to be about the same. This improves error rejection, reduces the effect of ringing, and increases the Pathfinder's effective velocity range by a factor of 1.4. If Beam 3 is aligned at an angle other than zero, use the EA command to describe the rotation between instrument Y-axis (beam 3) and ship forward axis.

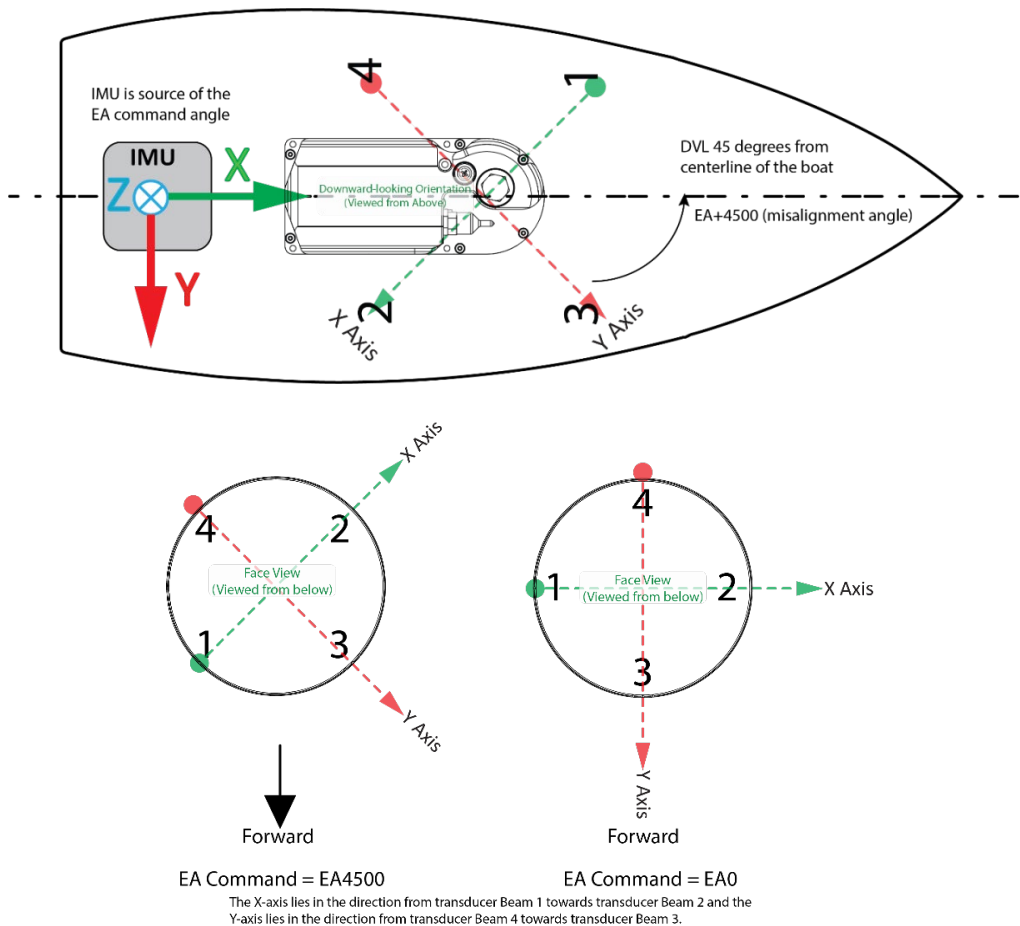

**Transducer Alignment Reference Points**

# Installing the DVL on the ROV

There are many options for mounting the Pathfinder systems and they depend on the application. Use the four mounting holes on the transducer (ROV version only).

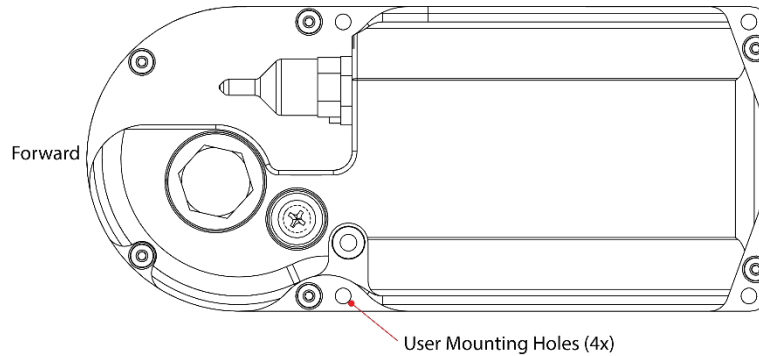

**End-Cap view of the transducer showing mounting holes**



Your Pathfinder DVL transducer housing is made of aluminum that is protected by sacrificial anodes and a hard anodize coat. **Do not connect other metal to the DVL.** Other metals may cause corrosion damage.

Use M6 isolating bushings and washers when mounting the DVL to a metal structure. Keep this in mind when fabricating a fixture, which materials to use, or deciding how to place it on the vehicle.



# Electrical Integration

## Grounding Issues

Multiple grounds connected to a vehicle hull or to a vehicle chassis can have undesirable consequences. Grounding problems can be avoided by implementing prudent grounding schemes.

The DVL has three isolated grounds in order to achieve the desired performance levels of the instrument. The grounding systems are as follows:

- Communication ground
- Power ground
- Chassis ground

Bypassing or shorting the DVL isolation / ground noise filter circuit will increase the sensitivity of the DVL to vehicle noise, which will increase noise floor in the instrument and in the data, thereby resulting in a reduced operational range and data contamination from interference. Additionally, bypassing of the DVL isolation/ground filter can lead to accelerated corrosion.



Your Pathfinder DVL transducer housing is made of aluminum that is protected by sacrificial anodes and a hard anodize coat and paint. **Do not connect other metal to the DVL.** Other metals may cause corrosion damage.

Use M6 isolating bushings and washers when mounting the DVL to a metal structure. Keep this in mind when fabricating a fixture, which materials to use, or deciding how to place it on the vehicle.



A direct connection to the Pathfinder OEM electronics shield or transducer head potential will reduce the ground isolation voltage from approximately 500VDC+ to 60VDC. If maintaining 500VDC of ground isolation is required, then TRDI recommends connecting the shield of the Pathfinder electronics to the vehicle chassis through a 1000VDC 0.01uF capacitor.

If 60VDC of ground isolation is acceptable, then the Pathfinder OEM shield may be directly connected to the vehicle chassis.

## Electro-Magnetic Interference (EMI)

The main sources of EMI are induced voltages from signal and power lines that are located in proximity to the effected component or signal. These problems are avoided or minimized by the proper routing of wires, proper shielding of wires and proper location of individual systems components. EMI is also caused by unwanted differences in potential on signal or ground electronic lines.



For more information, see the Pathfinder Guide, Chapter 2 – System Integration, Identifying EMI.

# Acoustic Integration

The following items must be taken into consideration when using the Pathfinder DVL.

**Flow Noise** – Water flowing over the transducer faces increases the acoustic noise level, which in turn decreases the operational range of the DVL. Flow noise can be reduced across the transducer faces by mounting the DVL behind a sea chest, fairing, or acoustic window. Flow noise can also be reduced by optimizing the transducer head type and design to conform to the platform hull form being used.

**Cavitation** – Cavitation is the formation of air bubbles due to the reduction of ambient pressure because of hydrodynamic flow conditions. Cavitation at the edges of the transducer or surrounding area near the transducer often results in increased acoustic noise, and a corresponding reduction in operating range. As with flow noise, cavitation can also be reduced by optimizing the transducer head type and design to the platform hull form being used.

**Ringling** – Ringing occurs in DVLs when the energy from the side lobes of the transmitted signal excites the metal portion of the DVL transducer such that a resonant condition occurs. This causes the transducer and anything attached to it to resonate at the system's transmit frequency. While some ringing is normal in DVLs, its magnitude must be minimized.

**Windows Use Considerations** – Windows can be used to produce overall performance improvements in vessel-mounted DVLs. There are several advantages and disadvantages to consider before using an acoustic window.

## Advantages

- Well will not fill with air bubbles caused by the ship moving through the surface water.
- Flow noise is reduced.
- The well can be filled with fresh water to limit corrosion.
- Barnacles cannot grow on the transducer faces. Barnacle growth is the number one cause of failure of the transducer beams.
- The transducer is protected from debris floating in the water.

## Disadvantages

- The range of the DVL may be reduced because the window can and will absorb some of the transmit and receive energy.
- The transmit signal could be reflected into the well, causing the well to “ring”. This will cause the data being collected during the ringing to be biased. Some vessels have reported a loss in range as great as 50 meters. As noted, the ringing may be damped by applying sound absorbing material on the well walls (standard neoprene wet suit material has been found to work well).
- The transmit signal could be reflected off the window and back into the other beams.

**SONAR Interference Considerations** – Interference from other acoustic and electromagnetic devices can cause velocity and direction bias. In extreme cases, interference may prevent the DVL from operating.



For more information, see the Pathfinder Guide, Chapter 2 – System Integration.

# Operational & Setup Integration

The following items must be taken into consideration when using the Pathfinder DVL.

**Unfavorable Environments** – There are certain environmental conditions where the DVL's errors may be large or where the instrument does not function at all.

- In the surf zone where waves are actively breaking, the acoustic beams may not be able to penetrate the bubble clouds, and even if they do, the sound speed may be significantly affected by the high concentration of bubbles. This changes the Doppler scale factor.
- The dense growth of weeds or kelp on the bottom may prevent the DVL from detecting the true bottom. If the DVL locks onto the top of the weeds by mistake, they may have motion relative to the bottom due to wave action, which would give inaccurate velocity measurements.
- In areas of high salinity (>35ppt), the absorption of the sound by the water column will reduce the altitude capability of the DVL. Absorption (maximum range) can also be affected by water temperature.
- In areas where the salinity varies as a function of location and/or time, the Doppler scale factor will be varying, and it may be necessary to integrate a speed-of-sound sensor into the navigation system to keep the velocity measurement errors to an acceptable value. Temperature gradients can cause similar issues. This is only for the Z-axis velocity, as Speed of Sound does not impact 2D velocities on a Phased Array Transducer.

**Triggering** – There are two methods for triggering the DVL:

- **Sending ASCII Character through Serial Port.** When the system is interfaced to a serial port (e.g. a navigation computer), the system can be setup to wait for an input before each ping. To setup the DVL in this fashion, clear the Auto Ping Cycle bit in the CF command by sending CFx0xxx, where the x's represent the settings of the other parameters. Start the DVL pinging with the CS command. The DVL will output a '<' before each ping and wait for input. Send any valid ASCII character to trigger the ping. The instrument will not enter sleep mode while it is waiting for the trigger.
- **Using Low-Latency Triggering.** The trigger methods shown above all have latencies ranging from a few milliseconds to a few hundred milliseconds, which may be excessive for high-precision applications. Consequently, TRDI has developed a low-latency trigger method (see CX command). To configure the DVL for low-latency triggering, set the CX command to enable trigger input. Start the DVL pinging with the CS command. The DVL will then wait for a trigger before each ping. Setting the trigger lines to a break state for no less than 10 microseconds sends the trigger. The DVL will then ping within 1 millisecond of the leading edge of the break pulse. Note that it is possible through the CX command settings to set a timeout for the DVL to wait for a Trigger and then if no Trigger occurs during that time it will either Self Deploy and never look for Trigger again or Ping once and then go back to waiting for Trigger. The input trigger voltage is 3.3VDC to 7VDC.



For more information, see the Pathfinder Guide, Chapter 2 – System Integration and Chapter 7 - Commands.

# INS Integration

The Pathfinder is integrated into the vehicle and connected to its network. The user accesses the Pathfinder's configuration HTML page and navigates to the network configuration page. The network configuration page provides a selection of PD outputs and a network configuration for each. The web page automatically refreshes and displays the current setting.

Network Settings

Network Configuration	STATIC	Link Status
Base IP Address	192.168.1.100	Active
Network Mask	255.255.255.0	
Gateway Address	192.168.1.1	
Name Server Address	192.168.1.1	
Command/Control Port	1033	

Output Formats

FORMAT	ENABLE	PROTOCOL	ADDRESS	PORT
PD0	ON	UDP	192.168.1.255	1001
PD4	OFF	UDP	10.20.230.23	1035
PD5	OFF	TCP	10.20.230.1	1036
PD6	OFF	TCP	10.20.230.1	1037
PD11	OFF	TCP	10.20.230.1	1038
PD13	OFF	TCP	10.20.230.1	1039
PD26	OFF	TCP	10.20.230.1	1040

Submit Reset

1. Configure the Pathfinder to output PD0 via UDP broadcast socket 255:255:255:255, port 1001.
2. The command file used by the Pathfinder enables Ethernet turnkey mode, and sets the delay start time to 30 seconds (CT command set to CT 2 30) (see [Creating or Modifying Command Files](#)).
3. Cycle power to the Pathfinder (wait 30 seconds between power off and power on) and monitor the output via Wireshark. The user can also command the DVL to start (as an alternative to waiting for Turn Key timeout) by sending a [CS command](#) to the DVL TCP Command and Control Port (192.168.1.100, port 1033).
4. 30 seconds after application of power the UDP broadcast packets from the Pathfinder are observed. Use *TRDI Toolz* to see that the DVL is outputting the Broadcast UDP data (255.255.255.255: port 1001).
5. The [Bottom-Track High Resolution Velocity \(5803h\)](#) and [Navigation Parameters Data \(2013h\)](#) blocks provide aid in the velocity measurement resolution and quality information for use in an Extended Kalman Filter (EKF) Inertial Navigation System (INS) solution. TIME-OF-VALIDITY output for highly accurate coupling with an INS further improves your resulting DVL aided INS position accuracy. See the [Navigation Parameters Data Format](#), bytes 54-69.
  - The Figure of Merit (FOM) is calculated for every velocity estimate and each beam
  - Estimates the standard velocity error
  - Confidence that when FOM is low, error is low
  - FOM can provide warning for individual beams, not entire velocity solution
  - May be used to filter data to reduce standard deviation and bias



# Choosing a Data Format

Deciding on which output data format to use depends on the needs of the deployment. The following describes the basics of the formats available.

- **PD0** – PD0 is Teledyne RD Instrument’s standard format. PD0 is a binary output format. It provides the most information possible including a header, fixed and variable leader, bottom track, and water profile information. The fixed and variable leader is a recording of time, DVL setup, orientation, heading, pitch, roll, temperature, pressure, and self-test diagnostic results. Data fields to be output are user selectable. PD0 has distance made good in the output if the Bottom Track High Resolution Velocity Output Format is selected. This format is selected via the #BJ command.



The Bottom-Track High Resolution Velocity (5803h) and Navigation Parameters Data (2013h) blocks provide aid in the velocity measurement resolution and quality information for use in an Extended Kalman Filter (EKF) Inertial Navigation System (INS) solution.

- **PD4** – PD4 is a binary output format of bottom track speed over the bottom, speed through the water, and range to bottom information.
- **PD5** – PD5 is a superset of PD4 and includes information on salinity, depth, pitch, roll, heading, and distance made good.
- **PD6** – PD6 is a text output format. Data is grouped into separate sentences containing system attitude data, timing and scaling, and speed through the water relative to the instrument, vehicle, and earth. Each sentence contains a unique starting delimiter and comma delimited fields. If PD6 is selected, there is no data written to the recorder.
- **PD11** is a text output format. It complies with the NMEA 0183 version 2.30 standard.
- **PD13** - PD13 outputs similar to PD6, except it adds Pressure and Range-to-bottom for all four beams and omits the System Health Monitor Data line.
- **PD26** - The PD26 format includes the \$VMVBW, \$VMDBT, and \$VMVLW NMEA Speed Log Formats.



For more information, see the Pathfinder Guide, Chapter 8 – Output Data Formats.

## PDDecoder Library in C language









The Teledyne Marine PDDecoder library is an open-source library written in C language to decode the PDO data formats that are commonly output by Teledyne Marine/Teledyne RD Instruments ADCPs. The definition and details of the PDO format can be found in any of the manuals under the section, Output Data Format.

Available for download from: <https://tm-portal.force.com/TMsoftwareportal>



# Want to know more?

Congratulations! You have completed the Pathfinder Integration Guide. Read the following chapters in the Pathfinder Guide for more detailed information.

-  **Chapter 1 – Pathfinder Overview**  
This chapter includes an overview of the Pathfinder features, options, computer and power requirements, and connecting to the Pathfinder DVL.
-  **Chapter 2 – System Integration**  
This chapter covers system integration in detail.
-  **Chapter 3 – Collecting Data**  
Use this chapter to create a command file that will be used to collect data.
-  **Chapter 4 – Maintenance**  
This chapter covers Pathfinder DVL maintenance. Use this section to make sure the Pathfinder is ready for a deployment.
-  **Chapter 5 – Returning Systems to TRDI for Service**  
Use this information to obtain a Return Material Authorization (RMA) number if the Pathfinder DVL needs to be returned to TRDI.
-  **Chapter 6 – Specifications**  
This chapter includes specifications and dimensions for the Pathfinder DVL (including outline installation drawings).
-  **Chapter 7 – Commands**  
This chapter defines the commands used by the Pathfinder.
-  **Chapter 8 – Output Data Formats**  
This chapter defines the output data formats used by the Pathfinder.

NOTES